

51
July
1987

elektor

INDIA

146

Rs. 7.50

electronics

AF WAVEFORM GENERATOR

Selective calling
in CB radio

Autoranging DMM

Printed resistors

Sun-to-Sun



NEW!

datalek

See inside for details

READ THIS AD SLOWLY...



Discover the speed and power of SCL 6502 Microprocessor

It's fast

Pipeline Architecture enables this Microprocessor to execute an instruction as it fetches the next one, saving few cycles, every time in the process.

Easy to handle instruction set
A simple set of 56 instruction when mixed with 13 addressing modes provides a versatile language for your programming needs.

Other prominent features.

★ True indexing capacity ★ Programmable stack pointer ★ Addressable memory up to 64K ★ Choice between external and on chip clock ★ 8 bit parallel processing ★ 8 bit bidirectional databus ★ Expandable, using support chips through interfaces.

Documentation

Extensive documentation, dealing with every bit of the chip thoroughly, helps you to integrate your imagination with the potential of the chip.

Support

There is a team of live-wire engineers, who can help you to realise the possibilities the chip offers. In every facet — generating the concept, conceiving and implementing the design, mapping your needs, etc. — They will be there guiding and working with you.

SCL 6502 the matchless chip!



Semiconductor Complex Ltd.

Regd. Office:
Semiconductor Complex Ltd.
(A Govt. of India Enterprise)
Phase VIII, S.A.S. Nagar-160 059
(Near Chandigarh) Punjab
Phones: 87585, 87265, 87397, 87409, 87310, 87443
Telex: 0395-270 LSI IN Gram: CHALSI

Delhi Office:
12/48, Malcha Marg, 1st Floor, Chanakyaapuri
New Delhi-110 021. Phones: 30144554, 3010426,
Telex: 031-65118

SCL 6500
FAMILY
COURSEWARE

SCL 6500
HARDWARE
MANUAL

SCL 6500
PROGRAMMING
MANUAL

Stocks available with:

WEST: Sales Industrials, Bombay, Ph: 2872169, General Electronics, Bombay, Ph: 4946422/ 897953/4946553, International Electronics, Pune, Ph: 65253, Hari Electronics, Ahmedabad, Ph: 342563/344697 NORTH: Mohan Radios, Delhi, Ph: 234578/2518675, U.P. Electronics, Saharanpur, Ph: 7318, Bharat Radio Centre, Lucknow, Ph: 45808, SOUTH: S.P.E.E.D.(P) Ltd., Madras, Ph: 452931/454810, Micro Electronics Incorporated, Madras Ph: 450217, Namech Consultants Pvt. Ltd., Bangalore, Ph: 561234, Safeguard Micro System, Bangalore, Ph: 568324, Shilba Electronics, Secunderabad, Ph: 73792, Marketing Engineers & Consultants, Hyderabad, Ph: 221293, EAST: Sham Electronics, Calcutta, Ph: 274867/269879 Premier Micro Systems Pvt. Ltd., Calcutta, Ph: 359039, India International, Patna, Ph: 52616.

Publisher: C.R. Chandarana
 Editor: Surendra Iyer
 Editorial Assistance: Ashok Dongre
 Circulation: J. Dhas
 Advertising: B.M. Mehta
 Production: C.N. Mithagari

Address:
 ELEKTOR ELECTRONICS PVT. LTD.
 52, C Proctor Road
 Bombay - 400 007 INDIA
 Telex: (011) 76661 ELEK IN

Overseas editions

Elektor Electronics
 Standflot House
 Bath Place
 High Street, Barnet
 Herts EN5 5XE U.K.
 Editor: Ian Seymour

Publitrion Publicacoes Tecnicas Ltda
 Av Ipiranga 1100, 9º andar
 CEP 01040 Sao Paulo - Brazil
 Editor: Juliano Barsali

Elektor sarl
 Route Nationale, Le Seau; B.P. 53
 59270 Bailleul - France
 Editors: D R S Meyer;

G C P Raedersdorf
 Elektor Verlag GmbH
 Susterfeld-Strasse 25
 1000 Aachen - West Germany
 Editor: E J A Krempelsauer

Elektor EPE
 Karasaka 14
 1673 Voula - Athens - Greece
 Editor: E Xanthoulis

Elektuur B.V.
 Peter Treckpoelstraat 2-4
 6191 VK Beek - the Netherlands
 Editor: P E L Kenemakers

Ferresia & Bento Ltda.
 R. D. Estrelina, 32 1º
 1000 Lisboa - Portugal
 Editor: Jorge Goncalves

Ingelek S.A.
 Av. Alfonso XIII, 141
 Madrid 16 - Spain
 Editor: A M Ferrer

In part:
 Kedhorn Holdings PTY Ltd
 Cnr Fox Valley Road &
 Kioleg Street
 Wahroonga NSW 2076 - Australia
 Editor: Roger Harrison

Electronic Press AB
 Box 63
 182 11 Danderyd - Sweden
 Editor: Bill Cedrum

The Circuits are for domestic use only.
 The submission of designs of articles of
 Elektor India implies permission to the
 publishers to alter and translate the text
 and designand to use the contents in
 other Elektor publications and activities.

The publishers cannot guarantee to
 return any material submitted to them.
 All drawings, photographs, printed
 circuit boards and articles published in
 Elektor India are copyright and may not
 be reproduced or imitated in whole or
 part without prior written permission of
 the publishers.

Patent protection may exist in respect of
 circuits, devices, components etc.
 described in this magazine.

The publishers do not accept
 responsibility for failing to identify such
 patent or other protection.

Distribution/Subscription

For Singapore, Malaysia and Brunel
 C.R. DASARATHA RAJ PRIVATE LIMITED
 126, Race Course Road,
 Singapore - 0821 Tel. 2931422

Printed At:
 Trupti Offset
 Bombay - 400 013
 Ph. 4923261, 4921354



Copyright © 1987 Elektor B.V.
 The Netherlands



Volume-5 Number-7
 July-1987

Sumit Singh

Electronics Technology

The magnetic way to painless brain stimulation	7.22
Design abstracts	7.45

Projects

Electronic weathercock	7.23
Selective calling in CB radios	7.24
Eight-channel multiplexer	7.26
AF Waveform generator	7.27
Printed resistors	7.31
Spot sine wave generator -2	7.33
Intercom for motor cyclists	7.39
Autorangeing digital multimeter	7.42

Information

Editorial	7.07
News ● News ● News ●	7.19
New products	7.56
Info/Data Sheets	7.73

Guide lines

Switch board	7.67
Datalek	7.69
Classified ads	7.72
Index of advertisers	7.72
Corrections	7.72

Selex-25

Inside view - of a low frequency amplifier stage	7.48
Amplifier variations	7.50
Valves	7.52
The push pull amplifier	7.53

WORLD ELECTRONICS MARKET EXPANDING AT 6-7 PER CENT

The World electronics market is forecast to expand at 6.9% in real terms in 1987 according to **Benn Electronics** in their new **Yearbook of Electronics Data**. The Benn Electronics Yearbook is published in two volumes, comprising West Europe (Volume 1) and America, Japan & Asia-Pacific (Volume 2), together covering 30 countries representing over 95% of the Free World electronics market. The total market for **electronic equipment and components** is forecast to reach US\$413 billion in 1987 compared with US\$387 billion in 1986 and US\$373 billion in 1985 at constant 1985 values and exchange rates. Growth during the remainder of the 1980's is expected to be similar to that in 1987 at an average annual rate of 6.6% to reach US\$500 billion in 1990. The US market growth was only 0.9% in 1986 but is forecast to increase to 5.7% in 1987. However, this is significantly slower than **Japan** with growth of 3.8% in 1986 and 8.2% in 1987 and **Europe** with growth of 8.4% in 1986 and 7.5% in 1987. Overall growth for the remaining countries is estimated as 5.5% in 1986 and nearly 9% in 1987 with **India** having the highest growth of around 18% for both years.

The appreciation of the yen severely restricted **Japanese** exports in 1986 and resulted in a drop in production of 1.2%. With the home market improving in 1987 and the yen stabilising, a growth in production of 5% is forecast, but this will still be well below overall home market growth as exports will remain depressed.

In the **USA** and **Europe**, production growth is forecast as being marginally higher than market growth but it is mainly the **Far East** countries that are benefiting from Japan's difficulties. Growth in production in 1987 is forecast to exceed 20% in South Korea, Singapore, Indonesia, Malaysia and Philippines. **India's** production is also growing strongly, but this is almost entirely to supply its own burgeoning market with very few exports.

The **Electronic Data Processing** sector is expected to

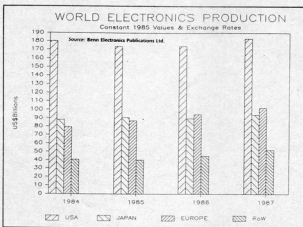
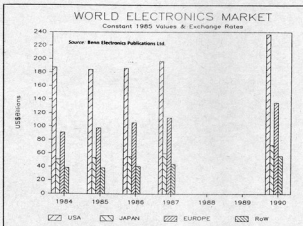
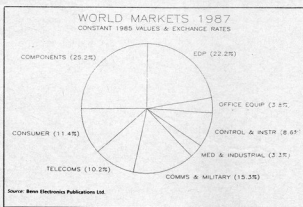

return to high growth in 1987 following a poor performance in 1986 when the US market contracted by an estimated 4.5%. A real growth of around 10% per annum will be maintained for the remainder of the decade to give a World market of US\$140 billion in 1990 at constant 1985 values.

The **consumer equipment** market improved significantly

in 1986 with a total estimated real growth of 3.9% as consumer expenditure in most countries increased. A similar growth rate is forecast for 1987, with growth slowing to an average 1.4% per annum for 1988-90 as previously high growth products such as video cassette recorders, compact disc players and camcorders approach maturity.

The market for **telecommunications** equipment will continue to grow at around 6% per annum overall but at a higher rate of 8 to 10% per annum in the less industrialised countries as equipment is updated and systems extended.

Growth in the **communications and military** sector will average around 4.5% per annum for 1987-90, being depressed by limited defence and space expenditure in the US. Only in Japan, where military expenditure is negligible, will the sector exhibit more robust growth, forecast as 6.6% per annum for 1987-90.

Following the recession in the semiconductor industry in 1985 the market for **active components** improved in 1986 with a growth of 4.6% increasing to around 10% per annum for 1987-1990. The market for **passive and audio components** is also expected to grow more strongly in response to increased production of equipment and the total World market for electronic components is forecast to reach US\$121 billion in 1990 at constant 1985 values, an annual growth averaging 6.8% for the period 1986-1990.

The **Yearbook of World Electronics Data 1987** is available in two volumes for **West Europe** (14th Edition) and **America, Japan & Asia-Pacific** (4th Edition). Together they survey the markets and production of electronics equipment and components in 30 countries with details of over 100 products in the EDP, Office Equipment, Control & Instrument, Industrial & Medical, Communications & Military, Telecommunications and Consumer Equipment sectors (Video, Audio, Other); and Active, Passive and Audio Components. In addition, there is a full review of developments in the electronics industry and economic prospects in each country.

The **Yearbook of World Electronics Data 1987** is priced at US\$1295, prices for individual volumes on application.

Benn Electronics Publications Ltd
Chiltern House
146 Midland Road
LUTON LU2 0BL

THE MAGNETIC WAY TO PAINLESS BRAIN STIMULATION

by Anthony T Barker, BEng PhD CEng MIEE (Department of Medical Physics & Clinical Engineering • Royal Hallamshire Hospital • Sheffield)

Ever since the work of Galvani and Volta in the 1790s it has been known that nerves and muscles can be stimulated by electric currents. Indeed, the whole neuromuscular system of the body is an intricate electrical signalling network.

Sensory nerves transmit impulses from the extremities of the body to the brain and central nervous system to pass on information such as temperature, force, pressure, texture and vibration. Motor nerves transmit signals in the opposite direction, from the brain to the muscles, to control bodily movement.

Electrical stimulation is a widespread and standard clinical tool for the investigation of disorders of the nervous system. Perhaps its most common application is to measure the speed at which signals travel along nerves.

If a nerve is stimulated, by applying a brief pulse of current via surface electrodes such as strips of metal or conducting rubber in contact with the skin, or needles inserted into the body, impulses will travel along the particular nerve. These impulses, known as action potentials, may be detected further along the nerve using similar electrodes connected to recording amplifiers, and the transit time or latency from stimulating to recording site can be measured.

Slowing allows detection

Diseases of the nervous system in general slow down the conduction velocity of the nerves, which can be up to 80 m/s in normal subjects, and so can be detected by such measurements.

While conventional electrical stimulation provides a valuable clinical tool in many applications, it does have some limitations. In particular, it is difficult to stimulate deep struc-

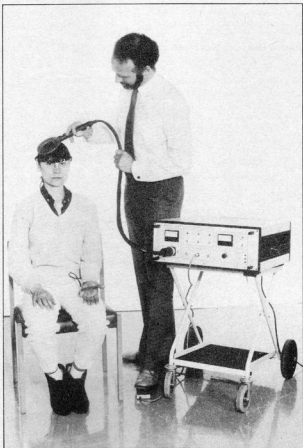

The prototype magnetic stimulator in use.

tures using surface electrodes without causing considerable pain, and the human brain is also virtually inaccessible because the high electrical resistance of the skull makes it difficult to pass current from the scalp to the brain.

The ability to stimulate the human brain would allow the measurement of transit times through the central motor pathways of the brain and spine, and it is known that these pathways are seriously affected in diseases such as multiple sclerosis.

Research started in 1975 in the Department of Medical Physics and Clinical Engineering at Sheffield University into a novel method of stimulating human

nerves with pulsed magnetic fields.

The stimulation of superficial nerves was reported in 1982, and in 1985 the first magnetic stimulation of the human brain and deep nerves throughout the body was described^(A).

Practical technique

Magnetic stimulation is now a practical clinical technique and the stimulators are to be manufactured in Britain by Physiological Instrumentation Ltd* under licence from Sheffield University. The technique has excited considerable worldwide attention because of its ability to measure the performance of previously inac-

cessible parts of the human nervous system.

The basic concept of magnetic stimulation is simple. By passing a brief duration (typically several hundred microseconds) very high amplitude pulse of current through a coil a corresponding pulse of magnetic field is produced. By the basic laws of electromagnetism this pulse of magnetic field will induce electrical currents in any conductor through which it passes, including the human body.

If the induced currents are of sufficient amplitude and duration they will stimulate nerves by exactly the same mechanism as if the currents had been applied via electrodes in contact with the body.

Advantages and disadvantages

Magnetic stimulation has advantages and disadvantages compared to conventional electrical stimulation. Its disadvantages are twofold.

First, the equipment is relatively bulky and costly because of the high current, high voltage technology involved. Commercial versions will be considerably smaller than the prototype but will still weigh ten to 20 kilograms and initially be limited to one stimulus every three seconds. The equivalent technology for electrical stimulators is very simple and they can be made both small and lightweight.

Second, the precise site under the stimulating coil at which the nerve is stimulated is not well defined. In theory, stimulation is most likely to occur around a loop of diameter approximately the same as the median diameter of the coil winding which is typically 70-100 mm. In practice, however, the uncertainty is usually considerably less than this because of the anatomy involved.

The equivalent uncertainty of

stimulation site with electrical stimulation is determined by the electrode spacing which is typically 10-50 mm.

Magnetic stimulation has, however, several important advantages. Magnetic fields of this type pass through all body structures—bone, fat or muscle—without attenuation. Hence, currents can readily be induced inside structures such as the skull allowing the brain to be stimulated with ease.

Painless

Magnetic stimulation is painless. Because the magnetic fields do not decrease rapidly with distance from the coil (fields 40 mm into the body will be typically one quarter of those at the surface) it is possible to reach deep structures without having very high fields at the surface of the body where most of the pain sensing structures lie. These sense organs have high thresholds to electrical stimulation compared with the structures to be stimu-

lated and hence are not stimulated by fields only four times greater than those applied to the deep nerve.

The corresponding fall-off in field with depth for electrical stimulation would be some 30 times greater and the resultant high surface fields that occur while attempting to stimulate deep nerves can cause considerable pain.

Magnetic stimulation is extremely easy to use in the clinic. Because the magnetic fields will pass unattenuated through clothing it is not necessary for the patient to undress. Similarly, it is not necessary to make electrical contact with the patient, as has to be done with conventional stimulation.

Indeed, it is not even necessary to make mechanical contact with the patient. Stimulation can be achieved with the coil held some tens of millimetres away from the skin, a feature which may be valuable in the assessment of seriously damaged areas of tissue such as head injuries.

Clinical applications

The first clinical study⁽¹⁾ carried out using magnetic stimulation has shown the ease with which slowing of nerve conduction within the brain and spine of patients suffering from multiple sclerosis can be detected and that, as would be expected, no slowing occurs in patients having motor neurone disease.

Evidence is beginning to accumulate that slowing, which has not yet caused clinical symptoms, can be detected. Because of the lack of discomfort associated with magnetic stimulation of the brain it is now possible, for the first time, to carry out repeated measurements on patients to quantify the effectiveness of new therapies for central nervous system disorders.

Other applications at present under investigation include the monitoring of central pathways during surgery to detect damage before it becomes irreversible and the assessment of deep and previously inac-

cessible peripheral nerves. At present, six magnetic stimulators, all constructed by Sheffield University, are in clinical use in England and the United States of America.

*Physiological Instrumentation Ltd, (Subsidiary of Novamatrix Medical Systems), Whitland Abbey, Whitland, Dyfed, Wales, SA34 0L6.

Bibliography

A. Barker, A.T. Jalinous, R. and Freeston, I.L. "Non-invasive magnetic stimulation of the human motor cortex". *Lancet*, 1985, 1:1106-1107.

B. Barker, A.T. Jalinous, R., Freeston I.L. and Jarrat, J.A. "Clinical evaluation of conduction time measurements in central motor pathways using magnetic stimulation of human brain". *Lancet*, 1986, 1:1325-1326.

electronic weathercock

Until recently, finding out which way the wind is blowing has always necessitated putting on one's shoes and stepping outside the door, thereby exposing oneself to the vagaries of the British climate. However with a little technical ingenuity, it is possible nowadays to know the precise direction of the wind without leaving the comfort of one's fireside. The electronic weathercock functions by connecting the vane to a potentiometer which turns with the vane. The voltage at the slider of the potentiometer is then proportional to the angle through which the vane is turned by the wind. The size of this voltage (and hence the direction of the wind) may be displayed in digital form using a UAA 170 and 16 LEDs. The circuit is designed so that there is a smooth interchange between the LEDs. Potentiometer P1 controls the brightness of the LEDs, whilst P2 is set such that, when the voltage at the slider of P3 (which is connected to the vane) is at a maximum, then D16 lights up. Further details regarding the UAA 170 may be found in *Elektron* 12, April 1976.

Potentiometer P3 may present a slight problem, in that it must be of a type which can be adjusted through 360°. If such a potentiometer proves difficult to find, then one solution is to use sixteen reed relays, each of which is enabled whenever a magnet connected to the vane passes over the relay. In this case a resistance divider replaces the potentiometer. Readers who are adept at making very small printed circuit boards, may like to replace the carbon track of a conventional potentiometer by a small 16-segment circuit board and connect each segment to the resistance divider.

The supply does not need to be stabilised, since the IC has an internal reference voltage output (pin 14) which is (gratefully) utilised. The maximum current through an LED is approx. 50 mA, thus a suitable supply would be a transformer producing 100 mA with a voltage of 9 or 12 V. The circuit is completed by a bridge rectifier and a 470 μ 25 V electrolytic capacitor.

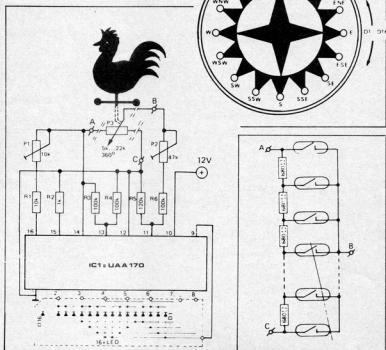

SELECTIVE CALLING IN CB RADIOS

by R Spengler

This simple to build unit enables CB operators to send and receive selective calls amidst all the hectic traffic on mostly overcrowded channels.

Base CB radio sets equipped with the present tone call unit can be left switched on all day without producing noise or conversations between other CB users, even if the signals trip the set squelch threshold. The receiver's AF amplifier is only enabled when a specific tone call is received from another station, which may be fixed or mobile. It is also possible to have the selective tone decoder automatically turn on the transmitter in the base station to acknowledge adequate reception of the caller (auto-answer facility).

The block diagram of the selective tone call system appears in Fig. 1. The upper blocks represent the tone transmitter, the lower the receiver, while those in the centre and to the right form the interface to the CB radio.

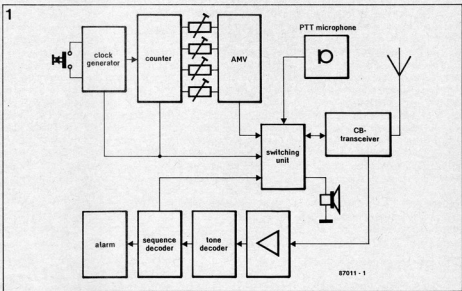

Fig. 1. Block diagram of the selective tone call system for CB radios.

Circuit description

The circuit diagram of the tone transmitter section is shown in Fig. 2. The main blocks in this circuit are a Schmitt-trigger based clock oscillator, N_2 , a counter, IC_2 , and an astable multivibrator set up around T_2 - T_3 .

When the tone call system is switched on with S_1 , IC_2 receives a brief reset pulse, and all outputs Q_n are consequently made logic low. Relay Re_1 is not activated, so that the CB radio can receive calls. When push-button S_2 is briefly operated, electrolytic capacitor C_4 is charged via R_1 , the clock oscillator is enabled, and Re_1 is energized, so that the output of AMV T_2 - T_3 is fed to the microphone input of the transceiver (point 1), which is switched to transmission at the same time because the PTT (push-to-talk) contact is grounded (point 2). Output Q_2 of decimal counter IC_2 goes high on the third clock pulse from N_2 . Each further

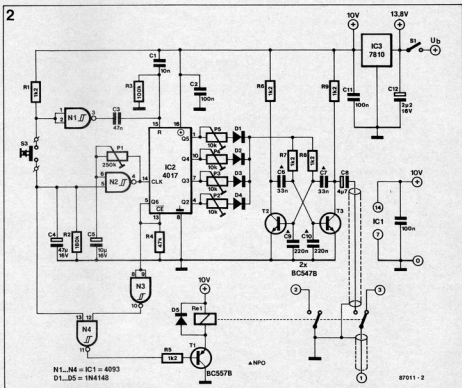

Fig. 2. The four-tone transmitter has its own power supply.

clock pulse switches on the next output, so that the voltage at junction R₁-R₄ steps in four levels, according to the adjustment of the preset at each of the counter outputs. The AMV can thus output a sequence of four pre-programmed frequencies. The seventh clock pulse from N₄ causes Q₄ to go high, and the counter is disabled via its \overline{CE} input. The output of N₄ goes low, so that R₄ is de-activated, and the receiver is enabled again. Immediately after pressing S₁, R₂ slowly discharges C₁, down to a voltage that is recognized as logic low by Schmitt-trigger N₁. The oscillator is disabled 5 to 7 seconds after depressing S₁, and can not be re-started to output a new tone sequence before this interval has lapsed.

The circuit diagram of the tone receiver appears in Fig. 3. The AF signal from the CB receiver is amplified in IC₄, and fed to four identical PLL tone decoders Type NE567. The tone sequence is evaluated in IC₁₄, and R₄ turns on the alarm circuit around Re₄. A three-tone chime is sounded by the loudspeaker connected to the output of IC₁₅. The AF signal from the CB transceiver is applied to the tone decoder circuit via an unused pin, 3, on the microphone/PTT socket. This involves connecting the AF signal at the input side of the volume potentiometer in the transceiver to pin 3 of the M/PTT socket with the aid of a short length of shielded wire. When it is preferred not to carry out this

modification in the transceiver, the AF signal from the external loudspeaker connection is a suitable alternative. Since this is generally a low-impedance signal, IC₄ in the tone decoder can be omitted, and the signal is applied direct to the junction of capacitors C₁₈-C₂₁. Note, however, that the operation of the tone decoder then depends on the volume setting of the transceiver; generally the best results are obtained when this is set to about 1/2 of its travel, the squelch being turned off.

A second modification to the CB radio has to do with the PTT switch on the (handheld) microphone. The switch contacts between microphone element and microphone wire (from pin 1 on the M/PTT socket) are con-

nected, so that the PTT switch only enables the transmitter, and Re₂ switches between the signal from the microphone and that from the tone transmitter. The operation of the selective tone decoder is fairly simple. When pin 3 on the M/PTT socket is utilized as set out above, C₁₃ feeds the AF signal to IC₄, which ensures the relatively low impedance for driving four PLL decoders in parallel. The centre frequency of each tone decoder IC₅-IC₈ is adjustable with an associated preset. When the PLL locks onto the incoming tone, pin 8 goes low, and the relevant LED lights. After a brief delay introduced with an R-C network (R₁₅-C₃₄ - R₁₈-C₃₇) the output of the respective NAND gate goes

3

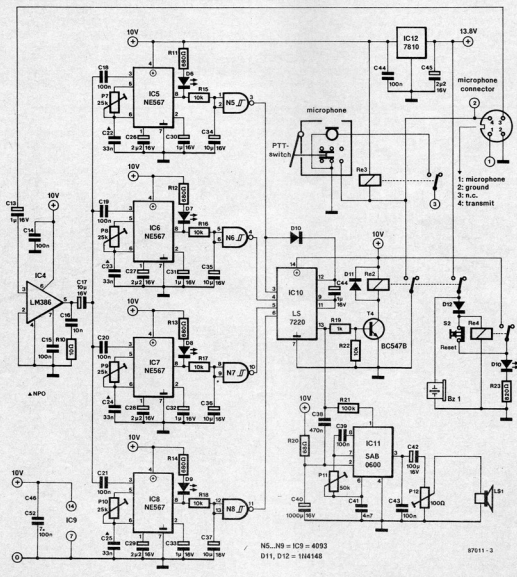

Fig. 3. Circuit diagram of the tone receiver and the interface to the CB radio set.

high. The inputs of code lock chip IC₁₅ must go high in succession to produce a logic high pulse at pin 13. The period of this pulse is determined with the value of C₄₄.

Driver T₄ activates Re₂, the transmitter is switched on, and the chime is sounded. At the same time, Re₃ switches the chime signal to the AF input of the transmitter, and the "call acknowledged" signal is automatically transmitted to the calling station. Components R₂₀ and C₁₉ prevent the chime from sounding any time the radio is turned on.

The mobile station

Although a three-tone chime is a fairly exclusive alarm in a car, a buzzer is more effective. This can be connected to a contact on Re₂ as shown in Fig. 3. The circuit around Re₄ is also intended for mobile CB operators. Since Re₄ is connected in a self-retaining circuit, LED D₁₀, which is preferably a blinking

type, is turned on when a valid tone call is received, and remains on until the car driver presses S₁. Any call to the mobile station is thus "retained" until the operator is available to answer it. The tone call system is fed from the CB radio, because the positive line in the vehicle generally carries considerable noise from the ignition system and the alternator.

Setting up

Connect either an AF amplifier or the input of a signal tracer to the output of the tone transmitter. Adjust presets P₁-P₅ such that a sequence of four clearly distinct tones is audible after pressing S₁. The speed of the clock generator is adjustable with P₄, whose alignment will be reverted to.

Use a 50k preset to temporarily feed the tone call to C₁₃ in the receiver. Set a relatively low clock speed with P₁, and adjust the PLL centre frequencies

(P₇-P₁₀) until LEDs D₁-D₉ light in sequence after pressing S₁. When the "slowest" setting of P₁ is still too fast, R₂ can be removed temporarily. Note that C₄ must be discharged before a new tone call can be sent. When the adjustment of the tone decoders is complete, the transmitter clock speed is increased until the tone sequence takes about one second.

When it is desired to equip more than two stations with this selective tone call system, all decoders must, of course, be set to the appropriate tone frequencies. A new tone sequence is readily made by swapping tones with the aid of a switch at the output of IC₂. At the receiver side, the relevant tone code can be selected with a switch connected to the inputs of IC_{1a}.

The use of two regulators to feed the circuits effectively precludes mutual disturbance in the operation. Frequency determining parts, notably

capacitors C₆, C₇, C₈, C₁₀ and C₂₂-C₂₅, must have a low temperature coefficient: NP0 types are preferred here, but good MKT capacitors should also give adequate results. The need for high stability components is best accounted for by the fact that the tone decoders are so selective that a frequency drift of about 100 Hz at the transmitter side already makes it impossible to call up the other station.

R

Note: the Type LS7270 code lock is available from Criclewood Electronics Limited • 40 Criclewood Broadway • London NW2 3ET. Telephone: 01 450 0995. The Type SAB0600 three-tone chime is available from Universal Semiconductor Devices Ltd, whose address and telephone number appear elsewhere in this magazine.

eight-channel multiplexer

When testing logic circuits it is often necessary to examine several different pulse trains simultaneously to check that the time-relationships between them are correct. This is difficult when only a single-channel, or at best a two-channel oscilloscope is available. Fortunately a simple eight-channel multiplexer can be constructed using only three TTL IC's. It will display up to eight pulse trains on a single-channel oscilloscope.

The heart of the circuit is a 74151, one-of-eight data selector. A BCD input from 0 to 7 applied to the data select inputs allows the data on the corresponding input 1 to 8 to appear at the output. The input codes are generated sequentially by a 7493 counter which is clocked at 16 MHz by a multi-vibrator comprising N1 to N3.

In order that the outputs should appear one above the other on the oscilloscope each output must have a different DC offset voltage added to it, otherwise the outputs would

all appear intermingled in a single trace. This offset voltage is generated by a simple D/A converter circuit consisting of N4 to N6 and R11 to R15. This generates a DC voltage proportional to the binary count of IC₂, which is added to the output at the junction of R₉ and R₁₆. The value of 'R' is not critical and can be anywhere between 1k and 10k. However, fairly close tolerance resistors should be used (1% or 2%), otherwise the eight traces may not be uniformly spaced on the screen.

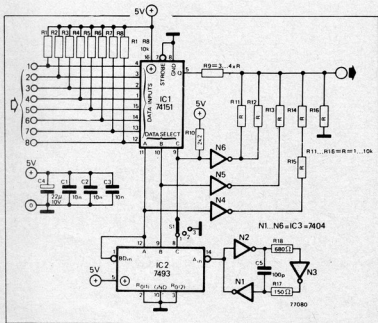

Switch S1 selects the number of channels which are displayed. In position 1 all eight channels are displayed. In position 2 the "C" input of the multiplexer is held high by R10, so channels 5-8 are displayed. In position 3 the "C" input is held low and channels 1-4 are displayed. The circuit can be used with input frequencies up to a few hundred kilohertz.

AF WAVEFORM GENERATOR

The AF waveform generator is intended primarily for use in an electrophonic synthesizer. It produces a number of waveforms without the use of filters. The transition from one waveform to another is continuous.

A sound consists of a number of discrete tones, which are known as harmonics. The lowest of these, or fundamental, is called the first harmonic, the next lowest the second harmonic, and so on. The tone-colour, also called timbre, of a sound is determined by the number of harmonics present in it. It follows that the tone-colour can be altered by adding or removing harmonics from the sound.

Harmonics are normally removed from a sound by means of passive filters. Unfortunately, these have the disadvantage of attenuating the low sound, so that additional amplification becomes necessary. Active filters give much better results with a number of musical instruments, but not with, for instance, the guitar.

The frequency spectrum of a guitar contains only very weak high harmonics. The only way of changing the tone-colour of such a signal is the introduction of non-linear distortion. This consist of adding higher harmonics by electronic means.

The present generator can produce sine-wave, pulse, square-wave, and triangular waveforms. There are a number of ways in which sounds can be produced in a synthesizer. The most important of these are subtractive synthesis; additive synthesis; direct synthesis; and enrichment synthesis.

In subtractive synthesis, a number of waveforms, each with a different composition of fundamental and harmonic frequencies, is used. The desired tone-colour is obtained by filtering the unwanted higher harmonics.

In additive synthesis, a great number of separate sine-wave generators is used, each of which has its own frequency and amplitude. The number of generators required makes this an expensive method.

In direct synthesis, a number of separate voltages is stored in a memory. When the memory is read in a certain sequence, a predetermined waveform is obtained.

In enrichment synthesis, as used in the present generator, a

number of higher harmonics is added to the fundamental (sine wave) signal. The great advantage of this method is the unbroken transition from one waveform to another (i.e., without the need of switches).

Block schematic

In Fig. 1, the VCO—voltage-controlled oscillator—provides the basic waveform for the generator. The fundamental operating frequency is set via inputs F_1 and F_2 (coarse and fine respectively). Steps of an octave are selected via input F_3 . The VCO generates a triangular waveform which is fed to a voltage-controlled amplifier—VCA. The output waveform of this amplifier depends on the level of the control voltages at inputs K and L . A number of possible waveforms is shown in Fig. 2: note that potentiometer P_1 determines control voltage U_K , while P_7 controls U_L . Note also that the control voltages may be derived from an external source.

The signal is then taken to a double limiter, which gives it an upper and a lower level. The limiter is shunted by a toggle amplifier—VCA₂—which doubles or trebles the fundamental frequency as determined by the control voltages at M and N . Fig. 3 gives some idea of the effect the control voltages have on the signal: note that P_5 determines control voltage U_M , while P_6 controls U_N . Note also that the control voltages may be derived from an external source.

Finally, the signal is passed to a third voltage-controlled amplifier—VCA₃—the output of which can be connected to any ordinary audio amplifier. The control voltage, U_P , at input P is derived from a keyboard, while U_Q is intended for amplitude modulation, for instance, to produce tremolo.

Circuit description

The VCO shown in Fig. 4 is fully temperature-compensated and its output is short-circuit-proof.

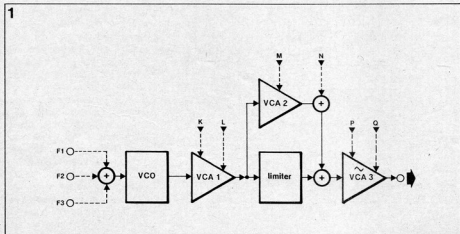

Fig. 1. Block schematic of the waveform generator.

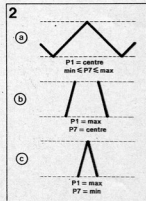
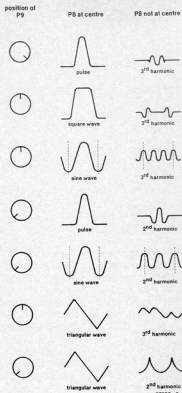

Fig. 2. Illustrating the effect of the presets in the waveform amplifier on the triangular waveform output of the VCO.

3

Fig. 3. Illustrating the effect of symmetry control P₈.

It outputs a triangular waveform that is offered to waveform amplifier VCA₁ in Fig. 5.

The waveform amplifier is based on an OTA—operational transconductance amplifier—which is half of a 13700. The first control voltage, U_x, which can be derived externally via K or taken from the wiper of P₁, determines the gain of the OTA within certain limits. The second control voltage, U_L, from an external source via L or taken from the wiper of P₁, enables a DC component to be added to the signal arriving from the VCO; in this way, the signal is either lowered or raised, depending on the control voltage. With P₇ at the centre of its travel, the triangular waveform is arranged symmetrically, and the slope of its edges is determined by the level of U_x—see Fig. 2b. A steeper edge results—after limiting—in a trapezoidal waveform. When U_x is maximum, the chopped signal will be very nearly a square wave.

When P₇ is turned fully anticlockwise, the vertex of the triangular waveform will remain

in place, but its base will be squashed as shown in Fig. 2c. The result is a pulse, the width of which is inversely proportional to the potential at the wiper of P₁. This means that the degree of non-linear distortion is dependent on the voltage level at the inverting input of A₁. Input R is intended to accept signals from an ADSR—attack, decay, sustain, release—generator. Because of zener diode D₁, the level of any ADSR input must lie above 2.5 V before the input can have any effect on the tone-colour.

The gain of the waveform amplifier is dependent on both the base current, I_B, of T₁, and the current through the linearizing diodes of A₂. Current I_B is limited by D_{2a} and R_{10a} to about 110 μA, which is just slightly higher than the control current flowing when the waveform is sinusoidal. Above this level, the gain is determined solely by the linearizing diodes since I_B is then virtually constant. The gain is, therefore, not affected by small fluctuations in the supply voltage.

Amplifier A₃ and the diodes in its output form the input stage for the external control voltage at L. The diodes prevent the output of A₃ rising above 0 V, since higher levels coupled with a high gain of the waveform amplifier might cause the disappearance of the entire signal.

The lower level of the triangular waveform at input X must be 0 V: small differences can be corrected with P₄.

When the circuit is set for asymmetrical pulse output, the OTA is driven one-sidedly, and its output must, therefore, be corrected to make it suitable for the limiter. This is effected by amplifier A₄, which adds a direct voltage to the distorted—signal to bring it back to its correct level for limiting.

The signal is limited by means of two anti-parallel-connected diodes, for which the base-collector junctions of T₁ and T₃ are used. The reason for this arrangement is that these junctions have a much better forward conduction characteristic than normal diodes. The limiter is current-controlled. When the voltage across R_{3c} exceeds a certain value, one of the diodes will conduct and the triangular waveform will be chopped. Moreover, the conse-

4

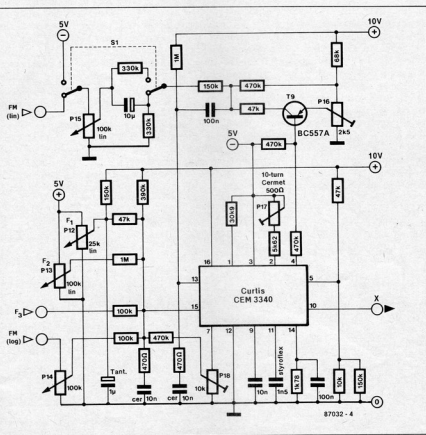
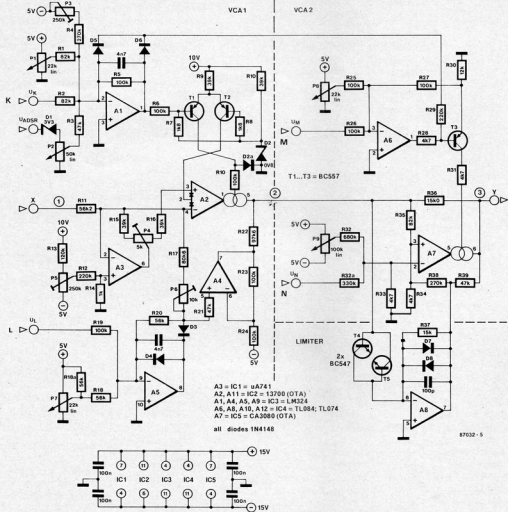
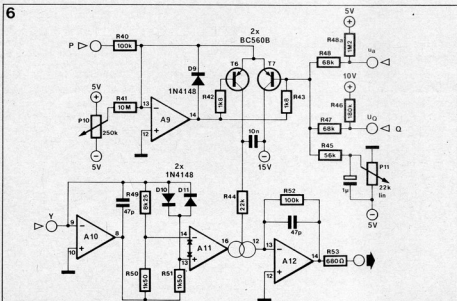

Fig. 4. Circuit diagram of the VCO.

Fig. 5. Circuit diagram of waveform amplifier VCA₁, toggle amplifier VCA₂, and limiter.Fig. 6. Circuit diagram of sine wave shaper and amplitude modulator VCA₃.

quent leakage current through R₃₁ is negated by a current in the opposite direction. This compensation itself is negated slightly later by silicon diodes D₇ and D₈. In this way all the angles of the triangular waveform are rounded nicely during the limiting process.

The limiter is shunted by VCA₂. Control voltage U_m, which can be provided by an external source via input M, or taken from the wiper of P₈, apart from providing extra gain, also sets the limits of the signal. The resulting pulse overdrives the input, Y, of VCA₃—see Fig. 6. In that case, the current flows via D₁₀ or D₁₁ to the non-inverting input of OTA A₁₁, which results in the signal changing direction. After reaching its peak, the voltage at the output declines back to nought.

This principle is also used in the toggle circuit associated with the limiter. By suitable con-

trol of the off-set voltage of A₇, the signal is altered as shown in Fig. 3 at will. The control voltage is derived from an external source via N, or taken from the wiper of P₉.

Amplifier A₈ exercises some control over the waveform amplifier via D₅ and R₂₉. Conversely, A₁ has some effect on the operation of T₃ via D₆ and R₂₉. This arrangement gives a measure of correction to the course of the cut-off frequencies of pulse signals.

As already mentioned briefly, A₅ processes signals from an external keyboard connected to input P. Potentiometer P₁₀ functions as the ENV ZERO SET control.

Amplifier A₁₀, diodes D₁₀ and D₁₁, and OTA A₁₁ form a sine wave shaper.

Alignment

1. Turn P₁, P₇, and P₈ fully anticlockwise, and set P₉ to the centre of its travel.
2. Connect the generator output to an audio amplifier. Set the bass control of the amplifier for minimum bass response.
3. Connect a frequency counter and LF oscilloscope to the output of the generator.
4. Connect input R to +5 V.
5. Adjust P₁₂ (coarse) and P₁₃ (fine) to obtain a VCO output of 200 Hz.
6. Set P₁ to the "9 o'clock" position and adjust P₂ and P₄ to obtain a pure sine wave on the oscilloscope.
7. Set P₇ to the centre of its travel, which will cause a number of even harmonics to be included in the output. These harmonics are removed by adjusting P₅ as appropriate. It may be necessary to readjust P₂ afterwards.
8. Eliminate any remaining imperfections on the sine wave by adjusting P₁₆ as appropriate. Note that S₁ should be in the upper position—see Fig. 4. Also note that P₁₆ sets the exact 50% duty factor of the VCO output.
9. Turn P₇ fully clockwise and set P₁ to the "3 o'clock" position.
10. Adjust P₅ to obtain a smooth rounding of the apex of the pulse output. Note that in this position the generator produces a minimum of noise: the apex should, therefore, be neither too pointed nor too flat.
11. Repeat actions 1 to 10 incl.

12. Set P₁ to the centre of its travel.
13. Remove all higher even harmonics from the output by means of P₇. The output should then be a square wave. The position of P₇ which gives a square wave output should be marked "SQUARE WAVE".
14. Set P₅ to the centre of its travel.
15. Adjust P₂ to obtain a sine wave output: mark this position of P₂ as "SINE WAVE". During this alignment, a symmetrical but inverted waveform will be produced: this contains a strong third harmonic, but not a second harmonic.
16. Connect a keyboard to input F₁ (1 V/octave).

17. Adjust P₁₇ to obtain pure sine waves at the 2nd, 4th, and 8th harmonics. Some fine correction of any imperfections is possible by means of P₁₈.

Choice of components

The design includes a number of matched diodes and transistors: D₇-D₈, D₁₀-D₁₁; and T₄-T₅. Correct matching of these components is important. In the case of the diodes, equality of the internal resistance is a good indication of correct matching. Where control voltages are derived from external sources, each control input needs a

discrete attenuator.

If presets P₁, P₅, P₈, and P₉ are used for the control of more than one VCA₁ and VCA₂ (polyphone operation), each of them should be buffered as shown in Fig. 8.

For correct operation of the generator, it is essential that all reference voltages are interdependent.

A suitable power supply is shown in Fig. 7. It is recommended that the supply to the VCO is separately regulated. The -15 V line needs a limiting resistor, R₈, the value of which depends on how many VCOs are used. Each VCO draws about 20 mA. The value of R₈ indicated in Fig. 7 is correct for one VCO.

The OTAs are supplied from the +10 V line.

Resistors R₁₈ and R₂₀ should be 1% types.

Finally . . .

The sensitivity of control input K is 1 V/octave (logarithmic). The control voltage for input L may be derived from a low-frequency oscillator to produce pulse-duration modulation—PDM.

Although the generator can provide a large variety of tone-colours, it is recommended to use one for each wanted voice (part). None the less, the second generator should preferably be a sine wave oscillator with linear FM input. The waveform generator is then used to provide the drive for that input. If an additional ring modulator is used, the signals from the generator and oscillator can be suitably mixed: the process is, of course, non-linear.

The generator may also be combined with a state-variable filter to enable certain frequencies to be accentuated.

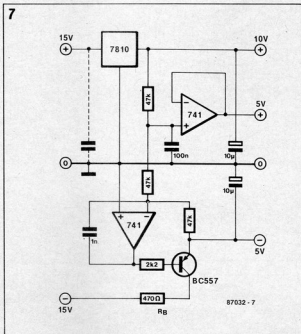

Fig. 7. Circuit diagram of possible power supply for the waveform generator.

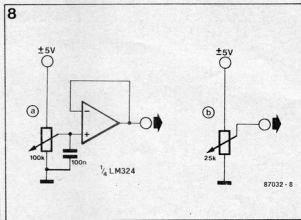

Fig. 8. Arrangement of presets for (a) polyphone operation, and (b) monophone operation.

PRINTED RESISTORS

by K Bachun

Introducing an attractive alternative to hassling with lots of low value, high power, resistors in testing, designing and setting up power supplies, AF amplifiers, and the like.

Have you ever worked on a circuit whose operation depends largely on a power resistor with a value below some 0.5Ω ? The experiments usually start with fitting a "near guess" power resistor from the junkbox, and end in disappointment at finding that the required value can only be realized with a tangled network of series and parallel connected resistors of sundry values and power ratings. Then, if the circuit finally works, the question arises how much resistance has actually been fitted. This is not at all easy to find out, since the common ohmmeter is not suitable for measuring below, say, 5Ω , and the tolerance on every individual resistor in the network makes it very hard, if not impossible, to calculate the total resistance. Further complications can arise if the replacement resistor proves unobtainable in the required power rating.

Low value resistors with a high power rating and adequate precision for most applications can be made relatively easily by

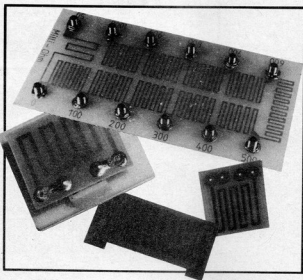

using the resistance of narrow, etched tracks on a printed circuit board. Most photo-resist boards have a $35 \mu\text{m}$ thick copper surface, and manufacturers generally specify a tolerance of $\pm 5\%$. The resistance of a track can be calculated if it is known that the resistivity of electrolytic copper is $0.0178 \Omega/\text{mm}^2/\text{m}$. Although copper is a highly

conductive substance, and hence enable making resistors with relatively small cross-sectional areas, the power rating of the resistors so made is surprisingly high, since the overall surface of the tracks is large relative to their cross-sectional area. Also, the use of epoxy boards ensures fairly good convection.

The good conductivity of copper results in relatively long tracks to achieve the required resistance. To save board space, the tracks can be arranged in a meander pattern, as will be seen further on.

The graphs in Fig. 1 show the correlation between track length and resistance for four track widths. The plotted lines were obtained from:

$$R = \rho L/A \text{ or } L = RA/\rho$$

where

R = the resistance in ohms;
 L = the track length in metres;
 A = the cross-sectional area of the track in mm^2 ;
 ρ = the resistivity of electrolytic copper: $0.0178 \Omega/\text{mm}^2/\text{m}$.

As a convenient starting point for the calculations, the track width should not be less than 1 mm, so that post-etching irregularities do not derate the tolerance or the dissipation. For optimum heat distribution on the board, the insulating space between tracks should at least equal their width.

When the printed resistor is

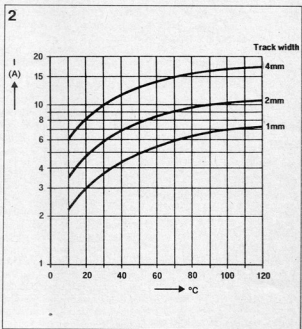
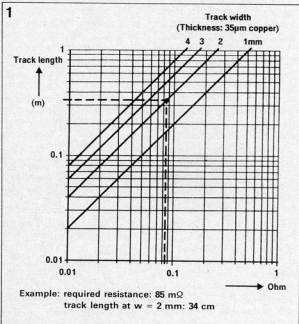

Fig. 1. Correlation between resistance and track length with four track widths as parameters.

Fig. 2. The increase in track temperature as a function of the current, plotted for three track widths.

meander-shaped, due account should be taken of the track length in the corners or curves. Although it is fairly difficult to establish the effective resistance in these areas, a reasonable approximation can be made to ensure sufficient accuracy for most practical applications.

The curves in Fig. 2 show the relation between the current passed through a track, and the resultant increase in temperature. The choice between a 1, 2 or 4 mm wide track can be made once the maximum permissible temperature increase, the ambient temperature, and the nature of the current (pulsed/continuous) have been established. To avoid the tracks being dislodged from the carrier, the temperature of the PCB must not exceed 80-100°C. Printed resistors will stand the occasional overload current, as long as this stays well below the point where the track burns out, and is not carried for excessive periods. Fortunately, the peak permissible current through a printed resistor is usually of the order of a multiple of the maximum continuous current rating. The stability of a printed resistor can be ensured by cooling it, reducing the effect of its temperature coefficient of about 0.4%/°C. Example: if the track width is 2 mm, and $I = 8 A$, $t_x = t_a + 50^\circ C$, and the tolerance is 20%. Printed resistors can thus be made to requirement, and may take the form of plug-in units that enable straightforward exchanging in an experimental set-up.

Alignment of the printed resistor is feasible in those cases where when high precision is required, or where a current is to be accurately adjusted. The tracks are then made slightly longer than strictly necessary, and the required resistance is

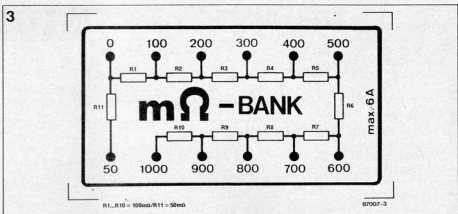

Fig. 3. Suggested front panel for the resistor bank.

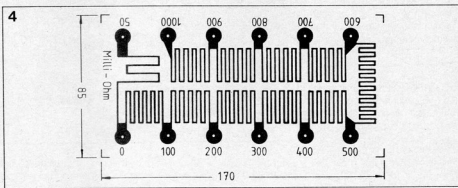

Fig. 4. Track side of the printed circuit board for making the milli-ohm bank (shown 50% reduced).

obtained with the aid of wire jumpers soldered onto a loop structure located in the middle of the track. Series connection of short tracks is a less favourable method, because the track junctions give rise to non-uniformity of the cross-sectional area, derating the maximum current.

The PCB-based resistor bank shown in Figs. 3 and 4 should prove a valuable and versatile tool for experiments with high power resistors in the 50 mΩ to 1 Ω range. The bank is composed of 10 series connected 100 mΩ resistors, and 1 50 mΩ type. All joints are tapped, and

the addition of the 50 mΩ resistor makes it possible to create resistors in small increments.

The taps on the ladder network are made with 4 mm wander sockets, so that the bank is readily connected to a circuit with the aid of a set of flexible test leads (use sufficiently strong wire and good-quality banana plugs). A multi-pole switch for selecting the resistors was considered unsuitable in view of its cost and inevitable susceptibility to contact problems. The sockets are secured direct onto the PCB, as shown in the photograph, and

each nut and threaded body is carefully soldered to the track. The completed circuit board conveniently serves as the front panel of the resistance bank, whose enclosure should hold a fan to cool the tracks when these are to carry continuous, high, currents. A suitably rated fast acting fuse may be added to prevent tracks from burning out owing to high current surges.

It is regretted that neither the printed circuit board nor the front panel for this project are available through the Readers Services.

NEWS • NEWS • NEWS • NEWS • NEWS

Record-breaking optical fibre cable

A £5.7 million contract for the world's longest unboosted undersea optical fibre communications cable has been

awarded jointly by British Telecom and the Telecommunications Authorities of Guernsey and Jersey to STC Submarine Systems.

The cable will run 135 km between Guernsey and the South Devon coast near Dartmouth. When it comes into service in the spring of 1989, its laser light pulses carrying speech, data, text, graphics, and facsimile

will travel the entire distance without regeneration.

The cable will have six fibre pairs of which two will be in use immediately the cable comes into service. The system will operate at 140 Mbit/s, which will give each pair a capacity of nearly 2,000 simultaneous phone calls.

The cable will use the latest single-mode technology with

high-performance lasers operating at a wavelength of 1.535 μm (195 THz). These radiate energy of high spectral purity, covering a much narrower frequency band than that of earlier designs. This narrow bandwidth reduces the effect of chromatic dispersion in the fibre, allowing the laser pulses to travel much further before regeneration becomes necessary.

SPOT SINE WAVE GENERATOR — 2

by M G Weigl

The article is concluded with details on the burst adaptor, and the construction of the instrument.

A *tone burst* is essentially composed of a controlled number of periods of an alternating voltage, usually a sine wave, and is used for testing and analysing the dynamic response of AF amplifiers, passive and active filters, and loudspeakers. In the case of the loudspeaker, for instance, a sine wave burst can be used to study the transient behaviour of a drive unit by measuring its acoustic output with the aid of a test microphone, fitted at a suitable distance in front of the cone. The signal from the microphone is then amplified and made visible on an oscilloscope. This method provides useful information about the occurrence of resonance effects, phase delay, ringing, etc., while it is also a practicable way of measuring the linear operating range of the drive unit under test. Since the burst is a relatively short signal, its duration being typically of the order of 5-10 periods, the loudspeaker can be driven to its full peak power capability without overloading the voice coil. In a response measurement based on the use of tone bursts, the pause duration is generally long relative to that of the burst, and hence allows sufficient time for the drive unit to cool off.

Pause, burst and phase

With reference to the block diagram of the burst extension, shown in Fig. 6, the signal from the pole of S_{4a} (see Part 1) is applied to sine wave amplitude control P_4 . The signal is then passed to a low pass filter, LP_{5b} ($f_c = 35$ kHz), to ensure the absence of spurious compo-

Burst adaptor extension for spot sine wave generator.

Technical features:

- Phase angle adjustable from 10 to 360°.
- Turn-on and turn-off phase angle are fully synchronous.
- Continuously variable Burst and Pause level.
- Continuously variable Burst and Pause duration.
- Also usable with other sine wave generators.
- Maximum input voltage: 5.6 Vrms.
- Maximum input frequency: 30 kHz.
- SYNC output for triggering an oscilloscope.

nents. A burst is obtained with the aid of electronic switch ES_1 , which is controlled with a pulse signal. During the pauses in the pulse train, ES_1 drives LP_{5a} ($f_c = 70$ kHz) with the attenuated signal available at the wiper of P_5 . During the active part of the switching pulse, LP_{5a} is fed with the full amplitude of the

sine wave signal.

The control of ES_1 is effected with a composite signal, obtained by appropriate setting of the time constant, τ , of the signals Phase, Burst and Pause. The period of Sync is not adjustable, but is always much longer than that of the slowest signal (10 Hz) in the circuit.

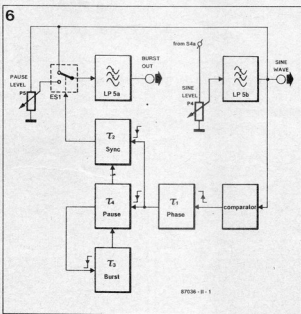

Fig. 6. Block diagram of the burst adaptor in the spot sine wave generator.

A burst of sine wave cycles

Figure 7 gives details on the connection of the burst extension to the sine wave generator described in Part 1 of this article. Low pass filters LP_1 - LP_4 are shown once more here to make clear that they are part of the circuit fitted onto the main subboard, which will be described in due course.

A simple ± 15 V supply based around IC_4 and IC_3 is accommodated on the subboard for feeding the filter modules.

Electronic switch ES_1 turns the sine wave on and off, and hence produces the burst with the aid of the CHOP signal. The amplitude of the sine wave is determined by the setting of P_4 (sine level), or P_5 (pause level), when CHOP is logic low or high, respectively.

The switch positions shown in Fig. 7 apply to the BURST OFF situation. Output signal TRIG controls the CHOP generator, and is shown disabled via ES_2 . The CHOP signal is therefore logic high, so that the sine wave is fed to the BURST output via P_5 , ES_1 and LP_{5a} . The same spot frequency is, of course, available at the SINE OUT socket, but the amplitude of the signal at this output and that at BURST can be adjusted separately with P_4 and P_5 . Both outputs should be terminated in 600 Ω .

Electronic switch ES_2 is activated when a CHOP signal is required for processing an aperiodical signal, such as noise. In that case, an internal CHOP signal is obtained by passing the output from LP_4 (100 Hz) to the TRIG output. This arrangement enables ready use of the burst adaptor with a variety of externally applied signals.

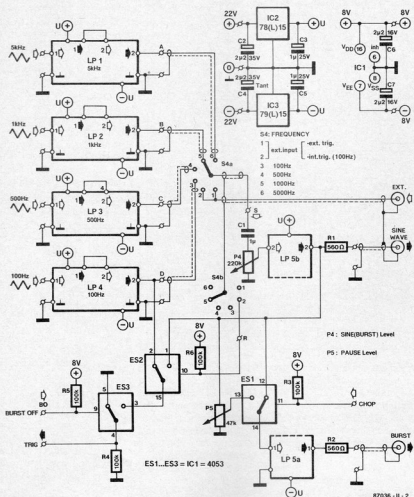

Fig. 7. The connections between the burst adaptor and the sine wave generator circuit. The control signals are routed with the aid of electronic switches.

The burst extension

The circuit diagram of the CHOP generator, i.e., the central part of the burst adaptor, appears in Fig. 8. Comparator IC1 converts any waveform at the TRIG input into a CMOS compatible, rectangular, input signal for monostable multivibrator MMV1, which is connected to trigger on the rising edge, and operates in the non-retriggerable mode, so that its mono time set with $P_1 + R_1 - C_1 \dots C_6$ must lapse before triggering can take place again. Rotary switch S_1 and potentiometer P_1 are the coarse and fine delay adjustments, respectively.

Since the TRIG signal is subject to delay before being converted into a usable CHOP signal, S_1 and P_1 in fact control the initial phase angle of the sine wave at the BURST output.

The most important parameters of the burst are the duration of the pause and the number of periods, and these can be set as required with the aid of monostables MMV2 and MMV4, respectively. Potentiometers are provided to ensure precise adjustments for a particular application: P_3 sets the length of the burst period, P_2 that of the pause.

Monostable MMV4 can be disabled by the Q signal from MMV3 to keep the burst and pause periods well separated. When the burst is completed, MMV4 is enabled again, and can be activated with the next negative trigger pulse from MMV1, since output Q of MMV3 goes high again.

Monostable MMV2 synchronizes the onset point (phase angle) of the sine wave

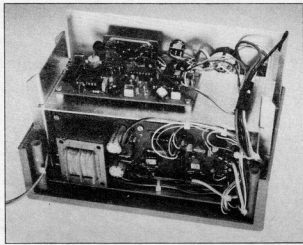
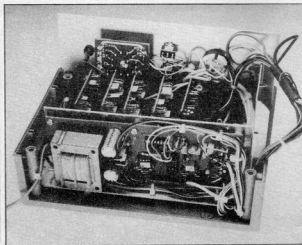

S1: PHASE (Input Frequency)

- 1 Burst off
- 2 10Hz
- 3 33Hz
- 4 100Hz
- 5 333Hz
- 6 1kHz
- 7 3kHz
- 8 10kHz
- 9 33kHz
- 10 Burst off

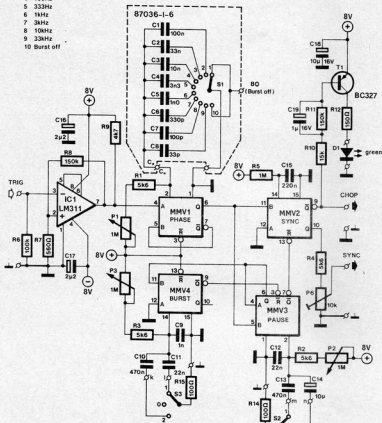

- | | |
|-----------|------------|
| S2: PAUSE | P1: PHASE |
| 0 25ms | 10°...360° |
| 1 500ms | |
| 2 10s | P2: PAUSE |
| | |
| S3: BURST | P3: BURST |
| 0 1ms | |
| 1 25ms | |
| 2 500ms | |

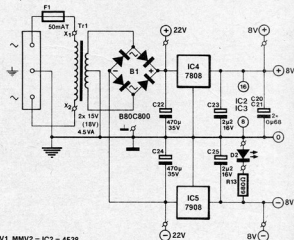

MMV1, MMV2 = IC2 = 4538
MMV3, MMV4 = IC3 = 4538

87036-II-3

burst. It is connected to trigger on negative pulse transitions (input A is grounded), but is reset during the burst pauses, because output \bar{Q} of MMV₃ is connected to its \bar{R} input. When the pause has lapsed, MMV₂ can be triggered again with the next negative-going pulse from MMV₁. MMV₂ remains set until a reset is forced by MMV₃, because it is connected in the retriggeable mode, and its output period, set with R₅-C₁₅, is long relative to that of the lowest input frequency (>10 Hz). The turn-off instant of the CHOP signal is fixed with MMV₁ reverting to its inactive state.

Briefly recapitulating the characteristics of the BURST signal: pause and burst duration are variable, and the entire signal can be phase-shifted over 10 to 360° to suit particular measurements.

The signal at output Q of MMV₂ is attenuated in divider R₄-P₆, and fed to the SYNC output for triggering an oscilloscope. Output Q of the same monostable turns on LED D₁ via driver T₁. This makes it possible to see the burst activity from the instrument's front panel.

The power supply for the spot sine wave generator and its built-in burst adaptor is a conventional design based on a pair of integrated voltage regulators Type 7808 and 7908. The unregulated ± 22 V output is connected to the regulators on the main busboard. LED D₂ is the power indicator of the spot sine wave generator.

The low pass filters for the burst and sine wave outputs are shown in Fig. 9, while Table 2 summarizes their technical characteristics. Presets P₁ and P₂ enable nulling the offset voltage at BURST and SINE OUT, respectively.

Construction and setting up

Commence the construction of the instrument with fitting all parts on the main busboard shown in Fig. 10. It is possible to fit potentiometers instead of multitrans presets for P₁ and P₂. When this is opted for, soldering pins and wires are required to make the necessary connections. The low pass filters are also fitted onto the busboard with the aid of soldering pins (8 off per filter), but it is also possible to use

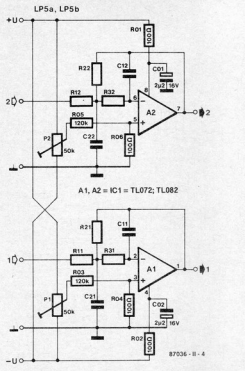

Fig. 9. The continuous sine wave and the sine wave burst are filtered prior to being output.

Table 2

Technical data LP5.

Filter type:	Bessel low-pass; 2nd-order with multiple feedback.
Cut-off frequency (f_c):	70 kHz (LP5a) 35 kHz (LP5b)
Filter coefficients:	A1 = 1.3617 B1 = 0.618
Overall amplification:	LP5a: $A_1 = A_0 = -1$ ($f_{\text{test}} < f_c$), LP5b: $A_1 = A_0 = -3$ ($f_{\text{test}} < f_c$).

Calculation of component values: please refer to Table 1 (LP1...LP4).

Parts list

(busboard, see Fig. 10)

Resistors ($\pm 5\%$):

$R_1, R_2 = 560\Omega$
 $R_3 \dots R_6$ incl. = 100K
 $P_2 = 220K$ multiturn preset or 220K potentiometer
 $P_3 = 47K$ multiturn preset or 47K potentiometer

Capacitors:

$C_1 = 1\mu$ (MKT)

$C_2, C_4 = 2\mu$; 35 V; tantalum.
 $C_3, C_5 = 1\mu$; 25 V; tantalum.
 $C_6, C_7 = 2\mu$; 16 V; tantalum.

Semiconductors:

IC1 = 4053
 IC2 = 7815 or 78L15
 IC3 = 7915 or 79L15

Miscellaneous:

$S_2 = 2$ -pole, 6-way rotary switch.
 PCB Type 87036-3 (not available through the Readers Services).

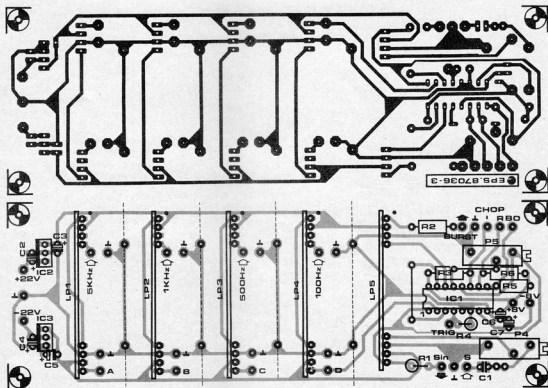

Fig. 10. The main circuit board for the spot sine wave generator holds the circuit shown in Fig. 7. The filter PCBs are fitted vertically.

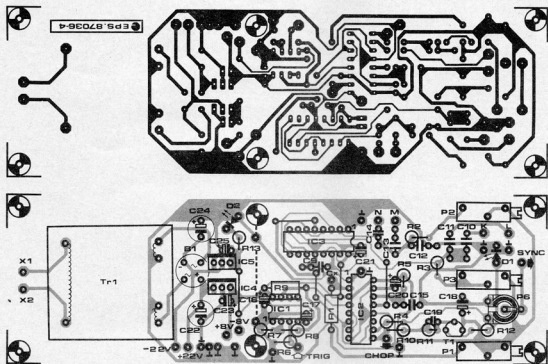

Fig. 11. This circuit board holds the power supply and the CHOP generator.

suitable mating PCB connectors. Note that holes have been provided on the main PCB to enable fitting metal screens between the filter modules.

Switch S_1 and associated timing capacitors and preferably fitted onto a separate PCB shown in Fig. 12. When this is not possible, each capacitor can be connected direct to the relevant switch contact, and each free capacitor terminal is then joined with the others to enable making a two-wire connection to the relevant points on the PCB.

The circuit board that holds LP_{5a} and LP_{5b} is completed as shown in Fig. 13.

Proceed with building the burst adaptor & supply PCB shown in Fig. 11. Potentiometers P_1 , P_2 and P_3 are mounted onto the instrument's front panel, and connected to the relevant points on the PCB with short lengths of screened wire, and soldering pins.

The power supply on the burst adaptor PCB is tested before fitting any of the ICs. Check the presence of $\pm 22V$ and $\pm 8V$ at the points indicated in the circuit diagram. When this ap-

Parts list

(see Figs. 11 & 12)

Resistors ($\pm 5\%$):

$R_1 \dots R_4$ incl. = 5K6
 R_5 = 1M0
 R_6 = 100K
 R_7 = 560R
 R_8, R_{11} = 150K
 R_9 = 4K7
 R_{10} = 15K
 R_{12} = 150R
 R_{13} = 680R
 R_{14}, R_{15} = 100R
 P_1, P_2, P_3 = 1M0 multiturn preset or 1M0 potentiometer.
 P_4 = 10K preset

Capacitors:

C_1 = 100n
 C_2 = 33n
 C_3 = 10n
 C_4 = 3n3
 C_5, C_8 = 1n0
 C_6 = 330p
 C_7 = 100p
 C_8 = 33p
 $IC_1 \dots C_8$ incl.: see Fig. 12
 C_{12}, C_{13} = 470n
 C_{17}, C_{18} = 22n
 C_{14}, C_{16} = 10 μ : 16 V tantalum
 C_{15} = 220n
 C_{19}, C_{17}, C_{25} = 2 μ : 16 V tantalum
 C_{19} = 1 μ : 16 V tantalum

C_{22}, C_{21} = 680n: 16 V tantalum
 C_{23}, C_{24} = 470 μ : 35 V

Semiconductors:

B_1 = 980C800
 D_1 = LED green
 D_2 = LED red
 T_1 = BC327
 IC_1 = LM311
 IC_2, IC_3 = 4538
 IC_4 = 7908
 IC_5 = 7908

Miscellaneous:

S_1 = single pole 10-way rotary switch (see Fig. 12, use a 12-way type with adjustable stop).
 S_2, S_3 = SPDT switch with centre position.
 Tr_1 = 2 \times 15 V or 2 \times 18 V; 4.5 VA for PCB mounting.
 F_1 = 50 mA delayed action fuse.
 Single-hole BNC sockets as required.
 Miniature SPDT mains switch.
 Mains entrance socket.
 PCB Type 87036-4, plus PCB Type 87036-6 (neither one available through the Readers Services).
 Suggested enclosure: Varibox Type 202-210368 (205 \times 137 \times 110 mm approx.).
 Note: the front panel foil shown in Fig. 14 is not available through the Readers Services.

12

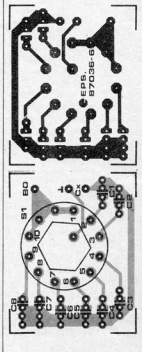

Fig. 12. Rotary switch S_1 for the phase angle setting can be fitted separately onto this board, along with 8 capacitors.

13

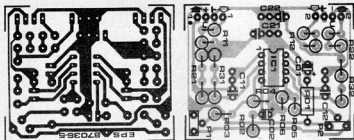

Fig. 13. This PCB holds the output low pass filters, and can be plugged onto the main busboard shown in Fig. 10.

14

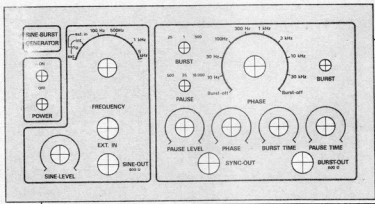

Fig. 14. Suggestion for a front panel foil for the spot sine wave generator (size: 197 × 104 mm).

pears to be in order, the supply is switched off, and the ICs are fitted. Turn the supply on again and check the operating voltage direct at the relevant terminals of the ICs. Screen the supply from the rest of the circuit by fitting a copper, brass or tinned metal sheet vertically onto the board, straight over the dashed line on the overlay. The screen is secured with two soldering pins.

The photographs of a prototype serve as a guide in fitting and interconnecting the boards in the Verobox enclosure. A suggestion for making a suitable front panel for this project can be found in Fig. 14. The burst adaptor & supply PCB is fitted vertically near the rear panel of the enclosure. This makes it possible to install a metal screen between this board and those for the generator circuitry and the filter modules.

It is suggested to mount the completed PCBs in the following order.

Commence with fitting all the necessary components onto the

front panel. The ± 22 V and ± 8 V supplies are provisionally connected to the main board, and the presence there of ± 15 V and ± 8 V is checked at all relevant points.

If everything is in order so far, the main board can be secured near the front panel of the enclosure. Refer to Fig. 7 for wiring details, and make sure that you use screened wires exactly as indicated in the circuit diagram, Fig. 7. Do not forget any of the ground connections. When you use potentiometers for P_4 and P_5 , these must also be connected in screened wire. Prepare the wires for the supply voltages, CHOP, BO, TRIG and those for the connection to the generator PCB, by soldering them to the appropriate terminals on the main busboard, and cutting the free ends to give suitable lengths to reach the relevant terminals on the burst adaptor & supply board and the generator board.

Now fit the burst adaptor & supply board in the enclosure, and connect the prepared

wires. Use screened wire for the connections to the front panel mounted controls P_1 - P_5 , S_1 - S_3 , and the SYNC output socket. Connect LEDs D_1 and D_2 , and pay due attention to the wiring of the mains ON/OFF switch, which is not shown in the circuit diagram because it is fitted as an external component.

The sine wave generator board is fed from the ± 8 V supply. The output socket for the tuning fork signal is fitted onto the rear panel of the enclosure. The generator board described last month is fitted on top of the main busboard, with a metal screen inserted between the two units—see the accompanying photographs of a prototype of the spot sine wave generator. The remaining wires from the main busboard and the supply are connected to the corresponding points on the generator board, and this finishes the construction of the instrument.

Sv

Parts list

(LP₁₀-LP₁₆; see Fig. 13)

Resistors: ($\pm 1\%$)

$R_{01}, R_{02}, R_{04}, R_{06} = 100R/J$

$R_{03}, R_{05} = 120K/J$

$R_{11}, R_{12} = 19K58 (16K + 3K5)$

$R_{13} = 25K01 (13K + 12K)$

$R_{21} = 75K04 (75K)$

$R_{22} = 23K15 (18K + 5K1)$

$R_{23} = 51K6 (51K + 620R)$

$P_1, P_2 = 50K$ preset for vertical mounting

Capacitors ($\pm 5\%$)

$C_{01}, C_{02} = 2\mu 2; 16 V; 20\%$; tantalum

$C_{11} = 47p$

$C_{12} = 22 p$

$C_{21}, C_{22} = 150p$

Semiconductor:

$IC_1 = TL072$ or $TL082$

Miscellaneous:

PCB Type 87036-5 (not available through the Readers Service).

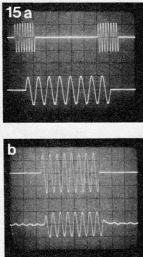
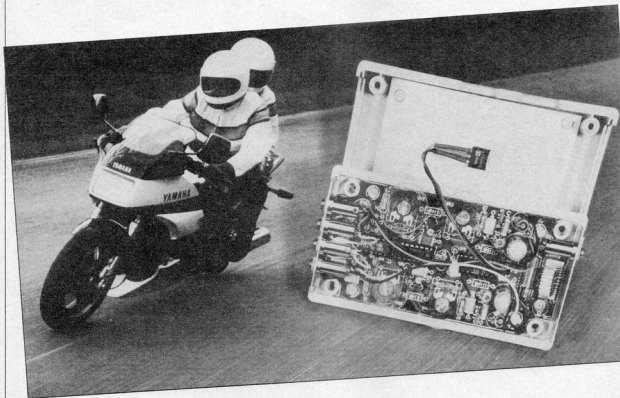

Fig. 15. Burst and continuous signal from the generator (15a), and the measured response of a typical squawker (15b).

INTERCOM FOR MOTORCYCLISTS



This advanced intercom enables motorcycle rider and passenger to chat undisturbedly while riding, thanks to effective ambient noise suppression and automatic muting facilities.

On a motorcycle, communication between the rider and the passenger on the rear seat is usually restricted to tapping on arms or gesturing in an effort to draw attention to noteworthy objects or events. The safety helmets and the ambient noise (wind, engine and traffic) make a normal conversation impossible, and many a motorcycle enthusiast is, therefore, confined to the noise in his own helmet. Even if he shouted at the top of his voice, his passenger would not hear him, although they sit quite close to one another. The intercom proposed here should appeal to all motorcyclists who recognize the dangers involved in gesturing

movements from the passenger while riding at relatively high speed. The unit is also eminently suited for instructing novice riders or those practising for work in a mail despatch service.

Noise cancelling and automatic mute

The circuit diagram in Fig. 1 shows that there are two microphones for the driver (channel A) and two for the passenger (channel B). This arrangement makes it possible to selectively suppress ambient noise. Electret condenser microphone

MC₂ supplies an AF voltage to the — input of opamp A₁, and MC₁ similarly drives the + input. The operation of the circuit becomes clear from studying Fig. 2, which shows the arrangement of the microphones and the headphone set in the helmet of driver and passenger. Referring again to channel A, MC₁ receives the spoken messages plus accompanying ambient noise, while MC₂ receives noise only. The differential amplifier in A₁ removes the noise component, so that the speech signal remains, and can be fed to IC₂ via C₅, P₁ and C₁₀. Stereo amplifier IC₂ functions as a double mono amplifier in this circuit. Its out-

put signal is fed to the headphone set of the passenger. The intercom has a built-in automatic mute facility, so that it is only operative when either the driver or the passenger starts to speak. The speech signal from opamp A₁ is applied to the — input of comparator A₂, whose threshold is defined with preset P₂ (MUTE α). Monostable MMV₁ is thus triggered by the peaks in the speech signal, and reverts to its inactive state when the speech pause is longer than about a second. Transistor T₂ then short-circuits the input of the headphone driver, IC₄. When a long enough speech signal is available, the collector-emitter junction of T₁ forms a

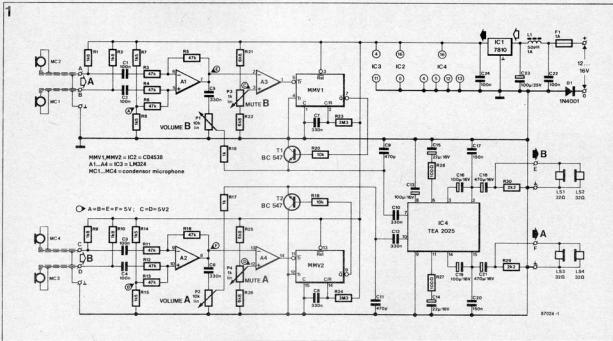

Fig. 1. Circuit diagram of the intercom for motorcyclists.

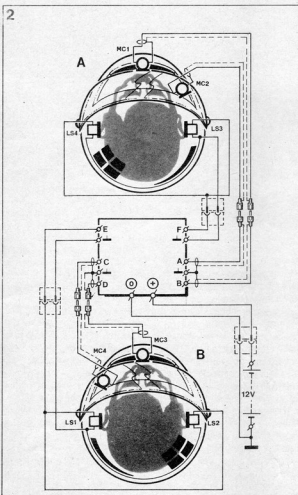
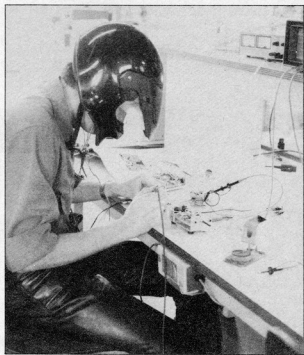

Fig. 2. This shows the preferred locations for the microphones and headphones inside the helmets.



Seen here is one of the designers working on a prototype.

high resistance, and the AF signal can reach the input of IC.

The supply for the intercom is taken from the motorcycle's 12 V battery with the aid of a 10 V series regulator, IC₃. Filter components L₁ and C₂ are required for suppressing alternator and other noise on the supply lines to the intercom, while D₁ affords protection against negative voltage surges.

Safety first

Figure 2 shows the preferred arrangement of the microphones and the loudspeakers (headphones) inside the safety helmets. The flat electret microphones are fitted underneath the lining inside the helmet to preclude head injuries. In this context, it is strongly suggested **not** to fit jack sockets in the helmet. A Walkman® headphone set is

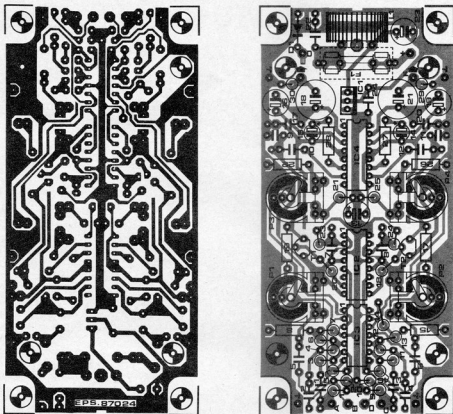

Fig. 3. The printed circuit board for making the intercom.

Parts list

Resistors ($\pm 5\%$):

R1; R2; R9; R10 = 1K8
 R3... R8 incl.;
 R11; R12; R13; R16 = 47K
 R7; R6; R14; R15 = 1K5
 R17; R18 = 1K0
 R19; R20 = 10K
 R21; R22; R23; R26 = 6K8
 R23; R24 = 3M3
 R27; R28 = 100R
 R31; R30 = 2K2
 P1; P2 = 10K preset for horizontal mounting.
 P3; P4 = 1K0 preset for horizontal mounting.

Capacitors:

C1... C4 incl.; C21; C22 = 100n
 C5... C8 incl.; C10; C12 = 330n
 C9; C11 = 470p
 C13; C14; C19 = 100 μ ; 16 V; radial
 C15; C16 = 22 μ ; 16 V; radial
 C17; C20 = 150n
 C18; C21 = 470 μ ; 16 V; radial
 C23 = 100 μ ; 25 V; radial

Semiconductors:

D1 = 1N4001
 T1; T2 = BC547
 IC1 = 7810
 IC2 = CD4538
 IC3 = LM324
 IC4 = TEA2025 (ITT, Thomson)

Miscellaneous:

L1 = 50 μ H; 1 A; toroidal suppressor choke.
 F1 = 100 mA delayed action fuse with PCB mount holder.
 MC1... MC4 = electret condenser microphone.
 PCB Type 87024 (see Readers Services page).
 Suitable ABS enclosure (waterproof).
 LS1; LS2 and LS3; LS4 = Walkman \otimes lightweight headphones.

eminently suited for this intercom, since it has a sufficiently long cord fitted with a small plug at the end. A similar cord and plug combination should be used for the microphone connections. In case of an accident, cord and plug will break instantaneously and can not inflict injuries on the wearer of the helmet.

Construction

The circuit board for the intercom is very compact in view of the limited space for mounting it onto a motorcycle. Fig. 3 shows that many resistors are mounted upright, while all electrolytic capacitors are radial types for PCB mounting.

The completed board is best cased in a strong, waterproof ABS enclosure with a built-in battery compartment to enable fitting the sockets. The cables to the helmets can be fed through small holes drilled into the associated lid.

The presets on the intercom board can be operated with the aid of short, home-made, shafts which are secured onto the central part of the wiper by means of two-component glue. When the adjustment is complete, the 4 holes in the intercom enclosure must each be sealed with a piece of waterproof adhesive tape.

St

From an idea by W v h Klooster & R Baltissen.

AUTORANGING DIGITAL MULTIMETER

An accurate, fully protected, 3¾ digit meter that can be made with an absolute minimum number of components.

Digital multimeters are nowadays offered in many different styles and at very competitive prices. In spite of this, many enthusiasts remain convinced that building good quality test equipment for use in their workshop is a very rewarding pastime.

The digital multimeter proposed in this article is a versatile and remarkably user-friendly test instrument that has some features not commonly found in its price bracket.

Circuit description

The Type ICL7139 from GE-Intersil is a recently introduced, high performance, low power, autoranging digital multimeter IC, whose main technical data are summarized in Table 1. When used as a DC voltmeter, the ICL7139 always displays the result of a conversion on the correct range. As can be seen from the front panel of the multimeter, shown in Fig. 3, the mode selector has but a single position for DC and AC voltage measurements. When set to DC voltage, the ICL7139 automatically selects one of four ranges to ensure optimum accuracy of the readout. For AC voltage measurement, the chip has one range: 400 V. The mode switch has a high (H) and a low (L) position for resistance and current measurements, and the ICL7139 automatically selects one of two ranges within these groups.

Four features of this design deserve attention. Firstly, the RMS (root-mean-square) value of 50 Hz sinusoidal input signals can be accurately measured in the 400 V AC range. Secondly, the use of a 3¾ digit LCD readout for the measuring

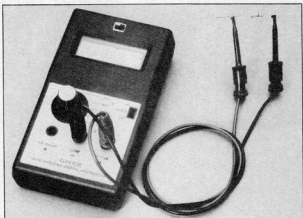

Auto-ranging DMM ICL7139

Technical characteristics:

- 13 ranges:
 - 4 DC voltage: 400 mV; 4 V; 40 V; 400 V
 - 1 AC voltage: 400 V
 - 4 DC current: 4 mA; 40 mA; 400 mA; 4 A
 - 4 Resistance: 4K Ω , 40K Ω , 400K Ω ; 4 M Ω
- Autoranging—first reading is always on correct range.
- On-chip duplex LCD driver includes 3 decimal points and 11 annunciators.
- No additional active components required.
- Low power dissipation: <20 mW.
- Battery life typically 1,000 hours.
- Average responding converter for sine wave inputs.
- Display hold input.
- Continuity output drives piezoelectric beeper.
- Low battery annunciator with on-chip detection.
- Guaranteed zero reading for 0 V input on all ranges.
- Accuracy: 400 Vdc: 1% of reading + 1.
 - all other Vdc ranges: 0.2% of reading + 1.
 - 4K Ω ; 400K Ω : 0.5% of reading + 8.
 - 40K Ω ; 4M Ω : 1% of reading + 9.
 - 4 mA; 400 mA: 0.5% of reading + 1.
 - 40 mA; 4 A: 0.2% of reading + 1.
 - 400 V/50 Hz: 0.2% of reading.
- Overvoltage protection with varistor or surge arrester.
- Current overload protection with fast fuse and diodes.

Principal data taken from manufacturer's preliminary data sheet.

ranges and associated display symbols. Thirdly, an on-chip supply level detector automatically warns of a flat battery by activating the LO BAT symbol on the display. Lastly, the proposed DMM has a built-in continuity tester that produces an audible signal when the measured resistance is less than 1K Ω . Also included is a hold function that enables "freezing" display readings.

With reference to the circuit diagram shown in Fig. 1, a few components require elaborating. Capacitor C₃ at the CV_{INT} input of the DMM chip must be a high stability type with a tolerance of not more than 2.5%. The ratio (R₃ + R₄)/R₇ must be kept at 10:1 within 0.05%; the absolute values of the resistors are less important here. Resistors R₁ + R₂ and R₃ + R₄ can be matched with the aid of preset P₁. The value of R₅ and R₆ must be correct within 0.5% for optimum accuracy on the resistance measurement ranges. Precision resistors R₈ + R₉ and R₁₀ determine the accuracy of the current measurements: both their absolute value and the 10⁴:10 ratio to R₇ must be correct within 0.5%.

An autoranging voltmeter can not work reliably without proper protection against input overvoltages. Although a varistor would be capable of adequate surge suppression with a response of the order of 25 ns, its equivalent capacitance of about 200 pF makes it less suitable for the present application. A gas-filled surge arrester has a slightly longer response time, but a very low parasitic capacitance: in the Type B2B600 used here it is only 2 pF while the device gives very good protection of

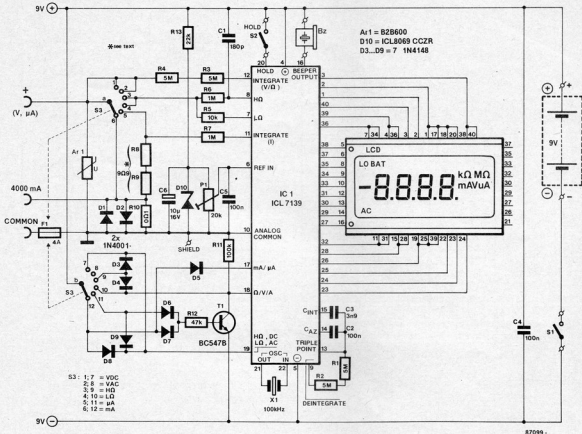

Fig. 1. Circuit diagram of the autoranging digital multimeter.

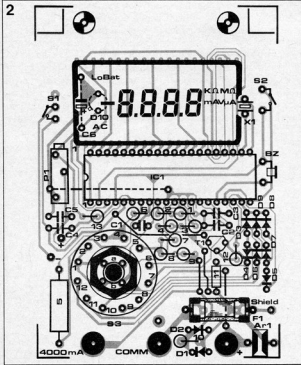

Fig. 2. The circuit board for the DMM fits in a standard Vero enclosure.

Parts list

Resistors (± 5%):

R1...R4 incl. = 5MΩ
 R5 = 10K; 5 W
 R6, R7 = 1MΩ; 0.1%
 R8 = 1R24F
 R9 = 8R66F (R4 + R9 = 9R9; 0.5%)
 R10 = 0R1; 2 W
 R11 = 100K
 R12 = 47K
 R13 = 22K
 P1 = 20K multiturn preset

Capacitors:

C1 = 180p
 C2; C4; C5 = 100n
 C3 = 3n9G polystyrene or silver-mica
 C6 = 10μ; 16 V; axial

Semiconductors:

D1; D2 = 1N4001
 D3...D9 incl. = 1N4148
 D10 = ICL8069CCZR (GE-Intersil) ▼
 IC1 = ICL7139 (GE-Intersil) ▼
 T1 = BC547B

Miscellaneous:

S1; S2 = miniature SPST slide switch.
 S3 = double pole, 6-way rotary switch for PCB mounting.
 F1 = fast 4 A fuse with PCB mount holder.

X1 = 100 kHz miniature quartz crystal.*
 Bz = piezoelectric beeper PB2720 (TOKO). ++
 Surge arrester B2B600 (Siemens).*
 9 V PP3 battery with clip-on leads.
 3 off insulated 4 mm wanders sockets.
 Enclosure Vero Type 65-2996H. Display Type 38D8R02H (LX-D).*
 PCB Type 87099 (see Readers Services page).
 We regret that the front panel foil for this project is not available through the Readers Services.

* Available from 2D Electronics • Wellington House • 2 Kentwood Hill • Reading. Telephone: (0734) 420440.

* Available from ElectroValue • Telephone: (0784) 33603.

** Available from Cirkit PLC • Telephone: (0992) 444111.

▼ Available from Universal Semiconductor Devices Ltd. • Telephone 01 348 9420.

* See text.

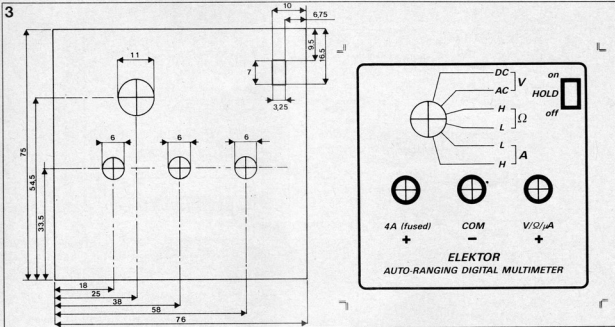
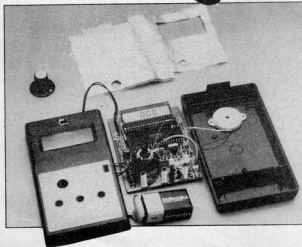
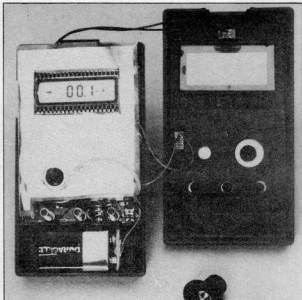

Fig. 3. Drilling template and suggested front panel foil for the DDM.



the sensitive inputs on the ICL7139. Diode D_{10} is a temperature-compensated, precision, 1.2 V reference. As already stated, the function of preset P_1 is not to set the voltage at the REF input of the DMM chip, but to compensate for the tolerance on the 5 M Ω resistors. Its adjustment is simply carried out with the aid of a sufficiently accurate digital multimeter, borrowed from a friend or a helpful electronics shopkeeper.

Rotary switch S_1 selects one of six measurements modes plus associated symbol on the LC display. Slide switch S_2 selects the HOLD mode. The multimeter is fed from a 9 V battery, and is switched on and off with S_1 . Since crystal X_1 clocks the RMS converter internal to the DMM chip, the stated value of 100 kHz is only valid for measuring 50 Hz input signals. For 60 Hz measurements, X_1 must be changed to a 120 kHz type.

Construction

The autoranging DMM is built on PC board Type 87099—see Fig. 2. The LC display is fitted into a wire-wrap socket or two sets of stacked terminal strips to ensure the required height above the circuit board. The three sockets for connecting the test leads are preferably mounted onto the enclosure lid to avoid excessive strain on the

PCB. The stated Vero enclosure has a battery compartment whose inside should be lined with expanded polystyrene. As shown on the accompanying photographs, a piece of aluminium foil is cut to size and insulated at both sides with self adhesive transparent foil. Great care should be exercised to avoid electrical contact between the aluminium foil and any component on the circuit board. A small area around the hole for the threaded part of the switch shaft should be left uninsulated. The screening foil is carefully secured by inserting it between a washer with a solder tag and the nut on the shaft of the rotary switch. A short wire is then run from the solder tag to point SHIELD on the printed circuit board.

DESIGN ABSTRACTS

The contents of this column are based on information obtained from manufacturers in the electronics industry, or their representatives, and do not imply practical experience by *Elektor Electronics* or its consultants.

Driver IC for Class D amplifiers

The driver IC Type TDA7260 from SGS-Ates offers a new concept for the output stages in car hi-fi systems. Driving four bridge-connected SGS-Ates Type 321 MOSFETs, it delivers 25 W (sinusoidal) into 2 Ω . At up to 80% efficiency heat sinks are not required.

Pulse-duration modulation—PDM—has been of practical importance in switch-mode power supplies for some time. Switched audio amplifiers are generally only found in AM broadcast transmitters. Sony's hi-fi PDM amplifier Type TA-N88, introduced in the late 1970s, had not really overcome the problems associated with this type of operation and was, therefore, withdrawn from the market within a very short time. In the TDA7260, SGS-Ates has succeeded in overcoming the problems associated with PDM, even under the exacting requirements of car hi-fi equipment.

The most serious problem in PDM is the stability of the modulator that has to provide a rectangular pulse with a width that is proportional to the amplitude of the AF signal. To achieve maximum power at a given voltage, duty factors of

between 5% and 95% are necessary, but at the same time overmodulation must be prevented. Owing to their—relatively—poor dynamic performance and distortion factor, PDM systems with fixed clock frequencies are not often found in high-quality audio equipment. Freely oscillating PDM amplifiers are much more suitable, but their frequency tends to decrease at high amplitudes. Where high switching frequencies are used (as, for instance, the 500 kHz in the TA-N88), the efficiency,

therefore, drops, while HF radiated noise increases.

SGS-Ates has solved these problems by stabilizing the frequency: depending on the amplitude, the hysteresis of the comparator is arranged in a manner that ensures optimum switching frequencies—see Fig. 2.

Unfortunately, frequency stabilizing can not prevent overmodulation and the consequent possibility of damage to the switching transistors. Because of that, the input opamp in Fig. 4 incorporates a limiter

which comes into action when the peak value of the input signal reaches 3 V. The limiter also provides a warning signal to pin 7 when the input signal approaches a peak value of 3 V. This warning signal drives an OTA—operational transconductance amplifier—in the TDA7232 in a manner that initially makes limiting unnecessary, thereby preventing an increase of the noise factor. Because of the small current density in PMOS FETs (higher ON resistance), a complementary push-pull switched output

Table 1 Technical specification

Maximum ratings	
Supply voltage, U_b	Max 30 V
Input voltage	Max 10 V
Floating input voltage	± 6 V
Peak output current	300 mA
Dissipation at $T_{\text{ambient}} = 70^\circ\text{C}$	Max 1 W
Electrical characteristics ($U_b = 14.4$ V; $T_a = 25^\circ\text{C}$)	
Power output into 2 ohms at 1 kHz	25 W
Distortion factor at 1 W into 2 ohms at 1 kHz	0.001
Voltage gain	12 dB
Switching frequency	120 kHz
Common-mode rejection	70 dB
Noise output voltage	15 mV
Efficiency at 25 W output into 2 ohms	85%

Fig. 1. Block schematic of the TDA7260

Fig. 2. Frequency stabilization in the TDA7260 prevents the sharp reduction in switching frequencies at high signal levels.

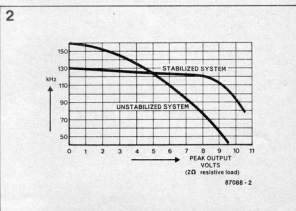
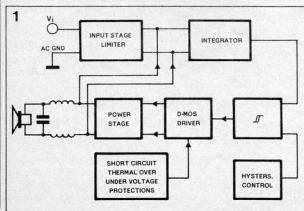

3

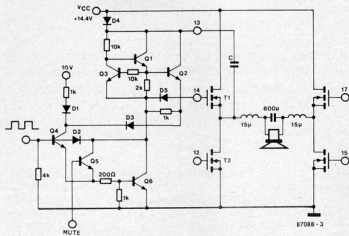
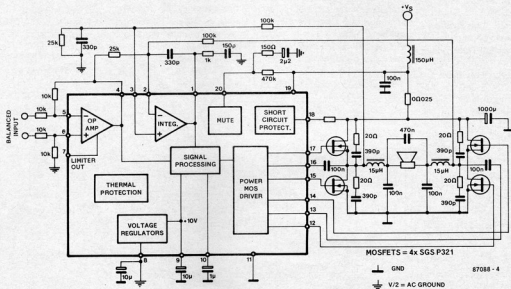

Fig. 3. The drivers at the output of the TDA7260 use bootstrapping.

Fig. 4. Circuit proposed by SGS-Ates for a 25 W car hi-fi amplifier with an efficiency of over 80% at the rated power output.

Fig. 5. Distortion vs frequency characteristic at 25 W into 2 Ω or 50 W into 1 Ω .

4



stage with NMOS FETs—SGS-Ates Type P321—is used. These FETs switch 60 V at 12 A with an ON resistance of typically 0.07 ohms. They are driven by a special stage in the 7260.

To ensure correct drive levels for the two upper FETs in the bridge, the gate voltage must be some 9 V higher than the supply voltage. The driver stage, therefore, contains two bootstrap stages that are capacitively coupled to the bridge outputs via pins 13 and 16. In theory, therefore, twice the supply voltage is available at pins 14 and 17 for the control of the FETs. The switching times of the driver stages are carefully arranged to prevent an

overlap with the corresponding conduction times of the FETs in one of the bridge halves. The transition delay of the drivers is smaller than 100 ns. The outputs of the driver stage can provide up to 300 mA at a maximum capacitive loading of 1800 pF. This means that even FETs with much greater power output can be driven effectively.

Another interesting feature is the facility for sub-sonic modulation of the switching frequency. An internally generated, very-low-frequency triangular signal varies the hysteresis of the comparator, and consequently the frequency of the rectangular signal, to reduce interference

5

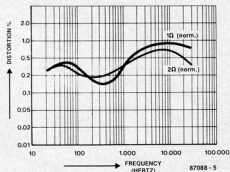

87088-5

6

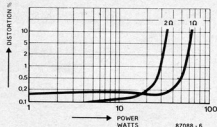

7

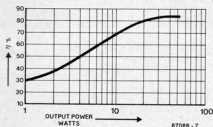

8

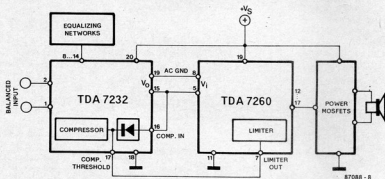

Fig. 6. Noise factor vs power output characteristic at 1 kHz.

Fig. 7. Efficiency vs power output characteristic.

Fig. 8. Block schematic of an active loudspeaker system based on the TDA7232-TDA7260 combination.

during radio reception. Such interference is further decreased by a low-resistance $150\ \mu\text{H}$ toroidal choke in the positive supply line. The 0.025-ohm resistance, decoupled by a $1000\ \mu\text{F}$ capacitor, serves as current sensor for the short-circuit protection stages at pin 18. The TDA7260 contains voltage regulators that provide an internal supply voltage of $10\ \text{V}$ and a $4.5\ \text{V}$ reference potential for the opamps.

The RC network at pin 20 provides an effective switch-on delay which ensures that the amplifier is not actuated until the internal supply voltage reaches $10\ \text{V}$. If that voltage exceeds $18\ \text{V}$ or drops below $9\ \text{V}$, the muting stage is actuated and renders the output stage inoperative.

Since the driver IC has a power dissipation of $900\ \text{mW}$ at $100\ ^\circ\text{C}$, an integrated thermal protection circuit is indispensable. When the IC overheats, it is completely switched off; once the temperature has dropped to a tolerable level, it is switched on again automatically. The input opamp in Fig. 4 has

been arranged as a (floating) symmetrical difference amplifier.

The bridge-connected output amplifier is terminated into two parallel-connected 4-ohm loudspeakers via $15\ \mu\text{H}$ low-resistance toroidal chokes.

Distortion, power output, and efficiency characteristics of the circuit in Fig. 4 are given in Fig. 5, Fig. 6, and Fig. 7 respectively.

At 80% efficiency and a driver output of about $1\ \text{W}$ (corre-

sponding to $25\ \text{W}$ power output into $2\ \text{ohms}$), the FETs dissipate not more than $1\ \text{W}$ each, so that a heat sink only becomes necessary at output powers above $25\ \text{W}$. In view of the low load impedance, the loudspeaker connections must be kept short and be made of thick cable.

A combination of the TDA7260 and TDA7232 is ideal for use in an active loudspeaker system; a schematic representation of this set-up is shown in Fig. 8.

Literature:

- TDA7260 Product Preview, SGS-Ates, May 1985.
- A high-performance, high-efficiency audio subsystem for car radios by Casini, et al, IEEE Transactions on Consumer Electronics, Vol. CE-31, No. 3, August 1985.
- Low-noise amplifier Type TDA7232, Elektor Electronics, June 1987.

9

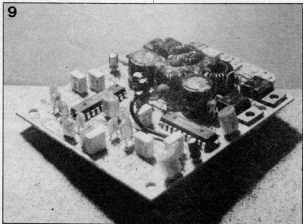

SGS-Ates (UK) Limited
Planar House
Walon Street
AYLESBURY HP21 7QJ

INSIDE VIEW

of a low frequency amplifier stage

It is not very difficult to see how a transistor, a capacitor or a resistor works individually. The explanations are quite simple and a few examples and comparisons can make the points clear. However, in case of circuits, where all the three types of components are interconnected and fed with a single battery pack, it becomes a bit difficult to visualise how the currents will flow in different paths and what voltages will appear at different points. The problem becomes still more complex when such a circuit is supplied with an AC signal at the input. How does this AC signal affect the currents and voltages in the circuit?

In short, how does one manage to understand a complex circuit? For instance, the amplifier circuit shown in figure 1 amplifies the AC signal presented at the input and gives an output signal which is almost ten times the input signal. Let us use this low frequency amplifier circuit to see how a circuit can be analysed to understand its operation.

DC Conditions

Let us first simplify the circuit and assume that no AC signal is present. Only DC conditions are present initially and the power supply causes only DC currents to flow through various parts of the circuit. As we know that capacitors do not allow DC currents to flow through, we shall neglect them for the time being. What remains is one transistor and four resistors as shown in figure 2. R1 and R2 form a voltage

divider which divides the supply voltage and the ratio is 2.7 : 1, so the voltage at the junction is approximately 2.4 V. This point is directly connected to the base of the transistor and hence the voltage on base of the transistor is naturally 2.4 V. This calculation is not very accurate because we have not considered the base current which flows also through R1. However, this is very small and can be neglected. The current through (R1 + R2) voltage divider is about 0.24 mA which is much greater than the base current.

The next point to observe is the base voltage, which we have already seen to be about 2.4 Volts. This is greater than the threshold voltage (0.6 to 0.7 V), and a collector current must flow. This current also flows through the emitter and thus there will be a voltage drop on R3 as well as R4 and R5.

The emitter voltage must be less than the base voltage by 0.6 V, i.e. 1.8 V. Because the base-emitter junction drops about 0.6V. The Ohm's law now gives us the emitter current as follows

$$\frac{1.8 \text{ V}}{1,22 \text{ k}\Omega} = 1.5 \text{ mA}$$

Once again, neglecting the base current which also flows through the emitter, we can say that the collector current is also 1.5 mA. Now, multiply this collector current by the collector resistance 2.2 K Ω and we get the voltage drop of 3.3 V. This leaves us with a voltage of 5.7 V on the collector terminal.

If we know the current gain of the particular transistor,

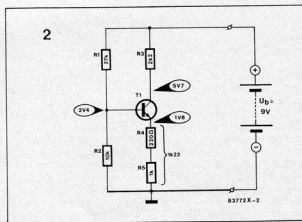
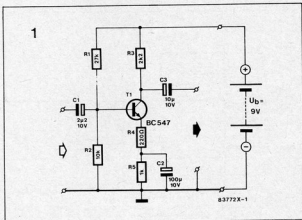
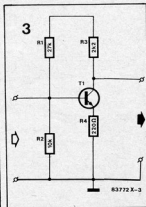
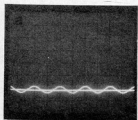

Figure 1:
A commonly used low frequency amplifier.

Figure 2:
During operation without any AC input signal, only DC currents flow in the circuit. They are caused by the DC supply voltage.

Figure 3:
When we consider only AC conditions, the capacitors behave like short circuited paths and can be replaced by direct connections to simplify the circuit.





Photographs

a. The input voltage is a pure AC voltage with a frequency of 100 Hz.

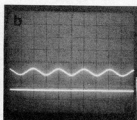

b. The input AC voltage superimposed on the DC voltage at the base. The DC voltage ensures that the transistor always remains conductive.

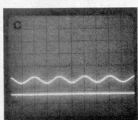

c. The emitter voltage is always less than the base voltage by 0.6 V. So the AC waveform remains same, but shifted down by 0.6 V, compared to that in photograph b.

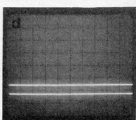

d. The voltage on R5 is a DC voltage because C2 behaves as a short circuit to the AC voltage across R5.

we can find out the base current. Assuming a value of 300 for the current gain, we get a base current of only 5 micro amperes. This is indeed negligible compared to the current through the voltage divider and that through the emitter. The calculated voltages are shown in the figure 2 at the base, emitter and collector of the transistor.

AC Conditions

So far we have seen the DC conditions only. Now let us visualise what happens when an AC signal is present at the input of the circuit. For analysing the AC conditions, we must consider the capacitors, because they are known to be conductors of AC currents. To simplify the matter, let us assume that the capacitors have a very low impedance so that they can be effectively replaced with short circuited

conducting paths for the AC currents. The result of this is shown in figure 3.

Let us now give an AC voltage of 100 mV (peak to peak) at the base of the transistor. The base voltage is thus superimposed by an AC voltage which alternates between +50 mV and -50 mV. As the emitter voltage must be less by about 0.6 V than the base voltage, it also goes up and down by 50 mV for each cycle. The difference remains constant at 0.6V between the base and emitter voltage. Note that for the AC conditions only R4 must be considered. As the voltage across R4 fluctuates, the current must also fluctuate, i.e. the emitter current must also fluctuate by:

$$\frac{100 \text{ mV}}{220 \Omega} = 0.45 \text{ mA}$$

(peak to peak).

The collector current is also same as the emitter current and thus it must also

fluctuate by 0.45 mA peak to peak. The collector resistance converts this fluctuation in to an AC voltage of $2.2 \text{ K}\Omega \times 0.45 \text{ mA} \approx 1 \text{ V}$ peak to peak. If we compare this AC voltage at the output with that at the input we can see that the output AC Voltage is 10 times larger than the input AC Voltage.

Please note that this is just an overall picture of how the circuit functions. The assumptions that we have made during our discussion may not be valid in case of a more complex practical circuit. Also, the DC and AC conditions can never be separately analysed as we have done, because both types of currents and voltages exist simultaneously in the circuit and they are superimposed on each other. We have assumed that the capacitors behave like short circuited paths for AC currents. This is not true in a practical

circuit. The capacitors behave like frequency dependent resistors for AC currents and the analysis becomes much more complex.

The DC and AC analysis that we have done here is purely an imaginary thought process based on various assumptions and approximations. This has been used only for the purpose of understanding the basic operation of the circuit and to provide you with a guide line for studying similar circuits.

The output at the collector is not a pure AC voltage, but a combination of both DC and AC, and that is why the coupling capacitor C3 must be used to pass on only the AC part to the next stage for further amplification.

For the sake of completeness, let us see the polarities of the input and output Voltages. During the positive half of the input voltage, the emitter voltage also goes through the positive half to maintain the difference of 0.6V. However, as the collector current goes through the positive half, the voltage drop on collector resistance increases and thus effectively the voltage on the collector goes through its negative half cycle. The amplifier thus inverts the input waveform during amplification. This is also called a 180° phase shift between input and output.

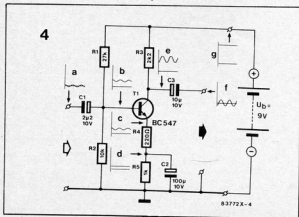
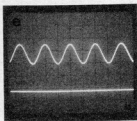
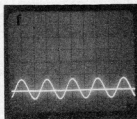

Figure 4: AC and DC conditions occur simultaneously in practical circuits. Various waveforms in the circuit are shown to explain how the input signal gets amplified and inverted at the output. The various waveforms are marked as a, b, cg are also photographed from the oscilloscope and given separately. The negative terminal of the battery was also connected to one of the oscilloscope channel continuously to show the relation between various waveforms and the negative ground line.



e. The collector voltage is formed by subtracting the drop across collector resistance from the supply voltage. As the collector current contains a DC as well as AC part, the

collector voltage is also made up of DC and AC. Note that the collector AC voltage goes through its positive half cycle when the base AC voltage is going through its negative half cycle.



f. The coupling capacitor allows only the AC voltage to pass through. Thus the output voltage is purely an AC voltage, which is an amplified and inverted replica of the input.

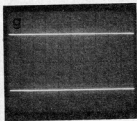

g. The DC supply voltage provides the energy required for amplification.

AMPLIFIER VARIATIONS

"Matching problem!", says the specialist, when somebody connects a record player to an amplifier — and the sound output is no good.

This "matching problem" can be frequently solved

with a simple, single stage amplifier. One such circuit is shown in figure 1. It has four variations, A, B, C, D, which differ only in their input impedance and amplification. The amplification factors and

other data are listed in table 1. The distortion factor with a value of 0.3% is quite acceptable and lies within the limits of Hi-Fi DIN standard 45 500. Another variation which can give a distortion value of 0% is

shown in figure 1 (E). Unfortunately the amplification factor is just 1:1.

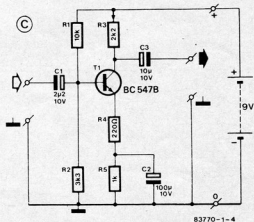
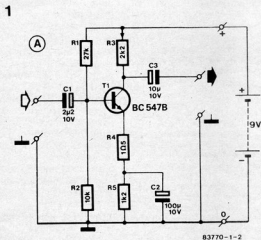

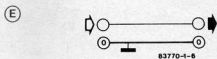
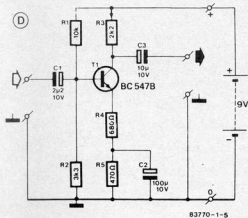
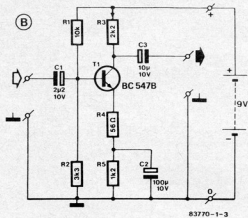

Construction

The circuit is quite simple and small. Two such amplifier stages for a stereo can be easily accommodated on a single SELEX PCB.

The circuit can be selected from the four given variations depending on the required amplification. If the

requirement is unknown, R4 and R5 can be temporarily soldered from the track side to try out which combination works best. Power supply can be derived from the amplifier or a separate battery pack can also be provided if the voltage of the amplifier power supply is not suitable. Any value between

- Component List**
 R1 = 27 KΩ
 R2 = 10 KΩ
 R3 = 2.2 K
 R4, R5 = As per table 1

- C1 = 2.2 µF/10V
 C2 = 100 µF/10V
 C3 = 10 µF/10V
 T1 = BC 547 B
 1 Standard SELEX PCB
 (Size 40x100 mm)

Figure 1: Different variations of the matching amplifier stage.

Figure 2: The smallest size of SELEX PCB has enough space for two amplifier stages of a stereo system.

Figure 3: All four variations A,B,C,D assembled on a double size SELEX PCB for testing in the Elektor Laboratory. The last variation of figure 1 (E) obviously needs no PCB or components!

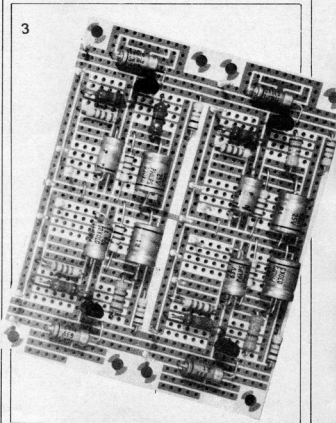
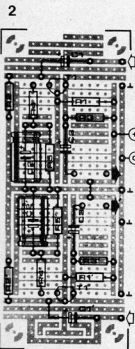

6 and 24 V is acceptable. The values given in table 1 are valid for a 9V supply. A plug in type 9V supply. A plug in type 9V adapter can also be used, however, in this case a 100 μ F electrolytic capacitor must be soldered on the PCB between plus and minus lines to eliminate noise and hum. The PCB must be installed inside the amplifier casing for proper shielding. If this is not possible, it

can be installed inside a small independent metallic enclosure. Shielded wires must be used for connections between the different units. The metallic casing is not to be connected with the earthing point.

If the record player or the cassette recorder has sufficient space, the PCB can be fitted inside the enclosure.

Table 1

Variation	A	B	C	D
R4	1.5 K Ω	56 Ω	220 Ω	680 Ω
R5	1.2 K Ω	1.2 K Ω	1 K Ω	470 Ω
Amplification Factor	100	30	10	3
Input Impedance	3.5 K Ω	4 K Ω	6 K Ω	7 K Ω
Output Impedance	2 K Ω	2 K Ω	2 K Ω	2 K Ω

VALVES

".... is it really true that once again some stereo systems are being constructed using valves?"

"Yes, however, these are only a very few exotic amplifier systems".

"But why this prehistoric technology is being revived? Aren't they really happy to have finally got rid of the old fashioned valves?"

"The valves are not as bad as you think. Even they have their plus points!"

"Well, just look at the heat they produce. Isn't it a sheer waste of energy?"

"Indeed, it is true, but there are some people who are ready to accept this."

"And then who would buy an amplifier that takes so much time to heat up and start functioning?"

"Not me. However as I have said, there are quite a few enthusiasts, who do not mind waiting for a minute before the amplifier starts functioning. Because, they are convinced that the valve system does sound better than a transistor amplifier."

"But even from the technical point of view, the transistor amplifiers are clearly superior"

"The technical problem with the valve systems is that they require a transformer."

"How come this is a problem? the transistor amplifiers also have a mains transformer."

"Yes, that is right, but I was referring to the output transformer and not the mains transformer. The valve system does have a mains transformer, but in addition to that, it also requires an output transformer to feed the loudspeakers."

"You mean a transformer can also transform music?"

"The music and speech appear in the amplifier as a mixture of various AC signals with frequencies of individual sounds, and a transformer can transform AC voltages. You already know this!"

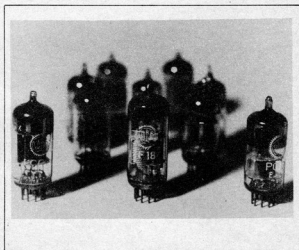

"Seems logical but, in that case why do we need an amplifier at all? We can just use a transformer to step up the voltage from the record player or cassette player directly and feed it to the loudspeaker. This would indeed be much simpler than a complicated amplifier, and we would need neither the valves nor the transformers"

"This would indeed be much simpler, only if it were to function! The record player and cassette player, unfortunately, supply very little voltage and very little current. When you step up the voltage with a transformer, the current is reduced in the same proportion. Because the transformer does not supply any energy. This reduced current would never be able to drive a loudspeaker. As against this, amplifier adds energy to the signals, which it draws from the mains.

"How does it add energy to the signal?"

"It is not very simple. In the amplifier, first the AC voltage is transformed and converted into DC voltage. Then depending on the incoming signal voltage, the amplifier provides a proportionally higher voltage to the loudspeakers, drawn from the DC supply voltage."

"This means that the amplifier is not an amplifier, but rather a controller which draws power from the supply voltage in a manner controlled by the input signal and gives it to the loudspeaker."

"Strictly speaking, yes, it is a controller. However, I was telling you about the transformers. You know that the loudspeaker has a low resistance....."

"... four Ohms or eight Ohms."

"So, they do not require a very high voltage but require a high current. Transistor amplifiers can supply high current without any problem and do not always need the

output transformers to feed loudspeakers."

"And Valves?"

"Valves require very high voltages compared to transistors, but they can supply very low currents. Therefore, the valve amplifiers require output transformers to step down the voltage and step up the current. Technically it is quite difficult to design a good output transformer which can reproduce all the audio frequencies true to life."

"Then why do people still prefer valve amplifiers?"

"As I said, it is difficult to design a good output transformer, but not impossible. Incidentally, some of the valve amplifiers are constructed with several valves, which can together supply the required current. The output transformer is not necessary in these amplifiers. Most of the Hi-Fi enthusiasts buy these amplifiers simply because they like the sound better."

THE PUSH-PULL AMPLIFIER

The principle of the "Push-Pull" Amplifier has a similarity with the woodcutters saw which handles at both the ends. These handles are held by two woodcutters. When one is pulling the saw other is pushing the advantage is obvious, the saw cuts in both the direction. The transistors in a push-pull amplifier work in a somewhat similar manner. One transistor amplifies the positive half of the AC signal, and the other amplifies the negative half. One such circuit is shown in figure 1. Emitters of both the transistors are connected together and the

voltage at this point is about half of the supply voltage. During operation, when C_e passes a positive half wave, T_a becomes conductive and more or less connects C_a to the positive pole of the supply voltage. T_b is blocked at the same time because it is a PNP transistor and C_e has connected the positive half cycle of the input signal to its base. When the negative half cycle of the input signal arrives, it is passed on by C_e again to the bases of the transistors. This time the conditions are reversed and T_b becomes

conductive, more or less connecting the capacitor C_a to the negative pole of the supply voltage.

Simultaneously, T_a is blocked due to a negative voltage on its base, because it is an NPN transistor.

In this manner, the voltage on capacitor can swing between the plus pole and minus pole of the supply voltage. Steady state voltage being half the supply voltage value. Due to the presence of capacitor C_a , the loudspeaker receives a true AC voltage which is

controlled by the input voltage.

Even though AC voltage amplification is possible with a single transistor, it is not very efficient because of the power losses in the collector and emitter resistors. In a push-pull circuit these resistors are absent, so there is no question of these extra

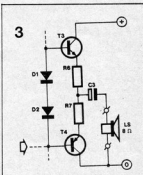
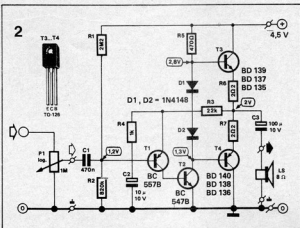
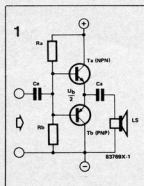

Figure 1: The basic principle of a push-pull amplifier. T_a amplifies positive half cycles and T_b amplifies negative half cycles of the AC input voltage. C_e is the coupling capacitor for the input AC signal and C_a is the coupling capacitor for the output AC signal.

Figure 2: A practical amplifier circuit with a push-pull output stage.

Figure 3: Details of the practical push-pull output stage. Two diodes are used between the bases to produce 1.5 V difference between them. This eliminates the disadvantage of the basic circuit, that the input voltage must be more than ± 0.6 V to have any effect on the circuit.

power losses. The basic circuit diagram in figure 1 is very simple compared to the circuit shown in figure 2. Even the circuit in figure 2 is very simple compared to the sophisticated Hi-Fi amplifiers. Therefore, it does not give a very high quality of sound but represents a practical easily realisable push-pull output stage for 8Ω loudspeakers. It can be operated from a 4.5V battery, and gives a peak power of about 250 mW for sine wave inputs. What more can one expect from a simple circuit and a supply voltage as low as 4.5V?

CIRCUIT

If we compare the circuits of figure 1 and 2, there is nothing in common except for the operating principle. The input circuit has completely changed as shown in figure 3. The two diodes between the base terminals carry current through R5 and T2. Their threshold voltages add up to 1.5V and appear between the bases. This modification is necessary to overcome the disadvantage of the original circuit that T_a conducts only when the positive halfwave is greater than +0.6V, and T_b conducts only when the negative halfwave goes below -0.6V; in between these limits, practically nothing happens to the circuit. Because of the two diodes, both the bases are at 0.6V each, compared to the emitters. The diodes also prevent excessive transistor currents.

The push pull stage can be compared to an emitter follower circuit. It has the characteristic features of emitter follower. The collectors are connected to the supply voltage poles and the output load is connected in the emitter circuit. In this case the load is formed by C3 and LS. Like the emitter follower, it does not amplify the input voltage but provides relatively high current at the output, without loading the input voltage. As we are also interested in voltage amplification, we use two more transistors in addition to the push-pull output stage. These are T1 and T2

which form the so called "driver" stage. This stage is separately shown in figure 4 also, for more clarity. R1 and R2 decide the base bias voltage of T1. The collector current flows into the base of T2 and gets further amplified by T2. The output voltage on the collector of T2 is then fed to the push-pull output stage. R5 functions as the collector resistance for T2.

R3 is shown in figure 4 as connected to the plus pole of the supply for the sake of simplicity. The emitter current of T1 flows through R3 and depends upon the voltage on R3.

This voltage (as seen from figure 2) is the difference between the output voltage of the amplifier and the input voltage, deducting 0.6 V base-emitter drop of T1. Thus the input stage is controlled by the input voltage but is also dependant on the output voltage through R3.

Let us take an example to see how this happens. Assume that a rapidly rising positive half wave lies at the input. Because of some reason, if T3 does not conduct rapidly enough, and

the output voltage rises too slowly. Consequently the voltage drop on R3 reduces, emitter current of T1 falls, and collector current of T2 (through R5) also falls. This causes the voltage drop on R5 to reduce and thus increase the base current of T3. The collector current of T3 thus rises more rapidly and the error which was assumed initially gets corrected.

This method of control is called negative feedback. The quality of the reproduction by the Hi-Fi output amplifiers depends on how cleverly the negative feedback circuit is designed.

A detail which we have still not touched is the R4/C2 combination. If we carefully observe the connections, we can see that R4 and R3 form an AC voltage divider. As C2 blocks the passage of DC currents, R4 and R3 work as a voltage divider only for AC Voltages. The reason for using a voltage divider in the negative feedback circuit is quite obvious. If the negative feedback voltage is given directly, it will throttle its own input signal and the circuit will stop amplifying completely.

As the capacitor C2 makes the voltage divider ineffective for DC Voltages, the input DC Voltage given by the voltage divider R1/R2 appears at the output increased by the threshold voltage of T1 and by the drop on R3. C1 couples the input AC to the base of T1 but prevents the DC base voltage of T1 from reaching the volume control potentiometer. C3 keeps away the DC Voltage from the loudspeaker.

Component layout is shown in figure 5 for those who would like to construct and test the circuit. Those who are interested in experimenting further, can vary R1 and R2, and R3 and R4 to observe the effect. Battery voltage can be increased to 9 V to get more power output. But in that case the output transistors must be provided with heat sinks.

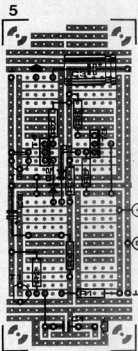

Figure 4: Details of the practical driver stage. The negative feedback is not shown here for the sake of simplicity.

Figure 5: Component layout for circuit of figure 2.

Component list

- R1 = 2.2 MΩ
- R2 = 820 KΩ
- R3 = 22 KΩ
- R4 = 1 KΩ
- R5 = 470 Ω
- R6, R7 = 2.2 Ω
- P1 = 1 MΩ (Log)
- C1 = 470 nF
- C2 = 10 μF/10 V
- C3 = 100 μF/10 V
- D1, D2 = 1N 4148
- T1 = BC 557 B
- T2 = BC 547 B
- T3 = BD 139
- T4 = BD 140
- LS = Loudspeaker (8 Ω/0.5 W)
- 1 SELEX Board (40 x 100 mm)
- 1 Battery 4.5V.

4

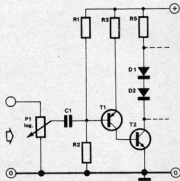

ACCSYS-1

Multipoint Temperature Scanner 'ACCSYS-1' is a unit that can monitor, control and log the temperature of 128 channels in its maximum configuration. The Scanner architecture is based on Intel's 8085 Microprocessor.

Its features are:

- 1) Auto or Manual operation.
- 2) The type of sensor for every channel is field programmable. It supports R,S,J,K & RTD's.
- 3) Software linearisation for all types and through out the measuring range of 0-1760°C ensuring ± 1 C accuracy.
- 4) Temperatures as low as -150°C can be measured, logged and controlled by the system.
- 5) The system has a CPU Module, Display & Key-board Module and an Analog Module.

- Other options are Printer Module and Control Annunciator Module.
- 6) The battery back-up contains rechargeable ni-cad cells for preserving the set point and other programs in RAM. The recharging of these cells on power-resumption is automatic and would take 6 hours to attain full charge.

For further details contact:

MICRO CONTROLS
1, Srinivasa Avenue Road
Ramakrishna Nagar
Mandaveli
Madras 600 028

BATTERY MONITORS

EQUILAB introduces new electronic auto battery monitors to know the exact condition of batteries under dynamic condition viz. below normal, normal, charging condition fully charged and over charged condition with the help of coloured LEDs. These monitors are also helpful in giving battery replacement warning signal as well as a fault in the charging mechanism. These are available in three models. BM3 gives three states of the battery viz. POOR, NORMAL & CHARGING. BM4 gives POOR, NORMAL, CHARGING & OVER-CHARGING state of battery and BM5 gives five conditions such as POOR, NORMAL, CHARGING, FULLY CHARGED AND OVER-CHARGED.

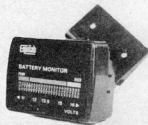

For further details contact:

ELECTRONIC INSTRUMENT LABORATORIES
B-69/004, Anand Nagar
Chh. Shivaji Road
Dahisar (East)
Bombay 400 068

CHIP RESISTORS & NETWORKS

Yokohama Electric Components Co. (YEC) Japan offers Thick and Thin Film Resistors. Thin film Resistors are available in plate type, Chip and SIP Networks. Thick Film Resistors are Chip Networks. These resistors are available with very low tolerances and T.C.R. upto $\pm 5 \text{ ppm}/^{\circ}\text{C}$.

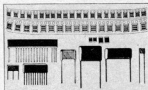

For further details contact:

HI-TECH RESISTORS PVT. LTD.
1003/04 Maker Chamber 5
Nariman Point
Bombay 400 021

LUXMETER

OPTO India has introduced a very sensitive, portable Compact Luxmeter for measurement of light levels. This is suitable for all photometric measurement in Science & Research as well as quality testing labs.



Contact:

AGRAWAL SALES ENTERPRISES
34 Ganesh Bazar
Jhansi 284 002.

OPHIR's LASER POWER/ENERGY MONITORS

OPHIR OPTICS LIMITED offer a very wide range of Power/Energy Monitors from 30 to 3000 Watts full scale.

All the monitors incorporate a specially designed Thermopile Absorber Disc which ensures accuracy and linearity, independent of beam shape/position, combined with a rapid response time. A complete range of volume and surface absorbers are available both for broad-band general purpose use and custom-tailored to a specific laser type.

The Disc's high sensitivity and up-to-date electronic design of the display unit allows an unusually large dynamic range extending over 4 decades in all models. All ranges are measured directly without beam attenuators, range extenders or reflection attachments.

Three different display options—Analog, Digital and Hand-Held Digital Displays are available giving the user utmost flexibility in configuring his monitor to his specific needs.



For Further details please contact:

TOSHNI-TEK INTERNATIONAL
267 Kilpauk Garden Road
Madras 600 010

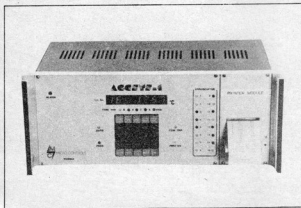

8085 MICROPROCESSOR TRAINER built in EPROM programmer, power supply, 2K CMOS/RAM with dry cell back up expandable to 8 K, 12 K user EPROM installed Rs. 2975/- All inclusive. EPROM Eraser Rs. 500/- Contact: NEW AGE ELECTRONICS, Third Floor, Laxmi Mahal, Near Vandana Cinema, Agra Road, Thane - 400 602.

KITS — Radio remote control call bell Rs. 150/-, Radio remote control music light Rs. 150/-, Ask projects list with 60 paise stamps. SUPER ELECTRONICS, Shivaji nagar, Barsi-413411

'Water level indicator with alarm' 1) With feather touch control system for Rs. 180/-, 2) Automatic Controller with probe Rs. 600/-, 3) Telephone amp Rs. 300/-. (Send 50% advance for V.P.P.) Dealers Solicited Contact: MINI MAX ELECTRONICS Alto-Porvorim Bardez Goa-403 521

CORRECTIONS

Computerscope

Nov 1986 P. 11-18

The following amendments apply to the circuit diagram in Fig. 2:

R₁₇=10K; R₁₅=2K2; C₁₅=10p.

High power

AF amplifier

July 1986 P. 7-18

The parts list should be modified to read:

C₁₃=100n.

ABC ELECTRONIC	7.14
ACE COMPONENTS	7.62
ADVANCE VIDEO LAB	7.66
ADVANI OERLIKON	7.06
APEX ELECTRONICS	7.63
BHARAT BIJLEE	7.63
CENTURY PERIPHERALS	7.55
CHAMPION ELECTRONICS	7.17
CHIP CHIP	7.71
COMTECH	7.10
CYCLO COMPUTERS	7.14
DEVICE ELECTRONICS	7.15
DONAU ELECTRONIK	7.64
DYNATRON ELECTRONICS	7.66
ECONOMY ELECTRONICS	7.66
ELCOT	7.08
ELECTRONICA SALES	7.14
EXCEL	7.66
G. S. ELECTRONICS	7.64
HITECH	7.58
IEAP	7.12
INDIAN ENGINEERING	7.65
INDUSTRIAL RADIO HOUSE	7.65
ION ELECTRICALS	7.58
JR. COMPUTER KIT	7.68
KLAS ELECTRONICS	7.64
LEADER ELECTRONICS	7.62
LOGIC PROBE	7.64
MECO INSTRUMENTS	7.59
MELTRON	7.57
MURUGAPPA ELECTRONICS	7.13
NCS ELECTRONICS	7.63
PAREKH MARKETING	7.18
PECTRON	7.68
PHILIPS INDIA	7.11
PIONEER ELECTRONICS	7.16
PRECIOUS BOOKS	7.60
PRECIOUS KITS	7.03
PROFESSIONAL ELECTRONICS	7.68
ROCHER ELECTRONICS	7.10
SAINI ELECTRONICS	7.18
SELPAGES	7.16
SEMICONDUCTOR COMPLEX	7.04
SIEMENS	7.09
SMJ ELECTRONICS	7.02
SOLDRON	7.65
TESTICA	7.12
TEXONIC INSTRUMENTS	7.59
TRIMURTI ELECTRONICS	7.16
UNLIMITED ELECTRONICS	7.59
VASAVI ELECTRONICS	7.18
VISHA ELECTRONICS	7.75

**Elektor Electronics
Infosheet-502**

Manufacturer: **Thomson-CSF**
Hunting House
Central way
Feltham

Distributors	Telephone
Abacus Electronics	(0635) 30680
Active Electronics	(0494) 441129
Add-on Devices	(07842) 47141
Aries Electronics	(0628) 37431
Beta Devices	01 971 6529
Consort Electronics	(0252) 871717
Dialogue Distribution	(0276) 682001
Merlin Electronics	(0622) 678888
Micromark Electronics	(0628) 72631
Polar Electronics	(0525) 377093
Prompto Electronics	01-554 6222
Semiconductor Supplies	01-643 1126
Steatite Microelectronics	021 454 2655

**Semiconductor manufacturers
and their UK distributors**

Manufacturer: **A E G TELEFUNKEN (UK) Ltd**
Market Street
Maidenhead SL6 8AE

Distributors	Telephone
Anglia Components	(0945) 63281
Aries Electronics	(0628) 37431
MCP Electronics	01-902 6941
Micromark Electronics	(0628) 72631
Polar Electronics	(0525) 377093
Thorp Electronic Components	(0925) 24277

Manufacturer: **A E I SEMICON**

Distributors	Telephone
Distributed Technology	(08 833) 6161
Langrex Supplies	01-677 2424
Micromark Electronics	(0628) 72631
Phab Electronics	01-805 4060
Polar Electronics	(0525) 377093

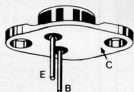
**Elektor Electronics
Datasheet-33**
**Transistors
Types BUX80 & BUX81**

TO-3

Dimensions in mm

The collector of these transistors is connected to the case.

Thermal resistance, R_{θ} (junction to case): 1.1 K/W

Turn-on time, t_{on} : $\leq 0.5 \mu s$ (typ 0.35 μs)

Turn-off time, t_{off} : $\leq 3.5 \mu s$ (typ 2.5 μs)

Fall time, t_f : typ 0.3 μs

All times measured with $I_{C(on)} = 5 A$; $I_{B(on)} = 1 A$; $-I_{B(off)} = 2 A$.

Subscription to **elektor**
is accepted from the current issue

INDIA:

1 Year Rs.75/- 2 Year Rs.140/- 3 Years Rs.200/-

OVERSEAS: 1 Year ONLY BY AIRMAIL Rs. 350/-
(SOUTHEAST & SOUTHWEST ASIA ONLY)

Enter details on both sides of this form

NEW/RENEWAL
SUB No.

PERIOD.....YR/S

RS.

CHEQUE/D/D/M.O. No.

DATE

Add. Rs.5/- for outstation cheques

Payments to: **Elektor Electronics Pvt.Ltd.**,
Chhotani Building 52C, Proctor Road, Grant Road (E), Bombay-400 007.

**Elektor Electronics
Infosheet-502**

 Manufacturer: **ADVANCE MICRO DEVICES
(AMD)**

Distributors	Telephone
Active Electronics	(0494) 441129
Avigupo of Britain	(0628) 34555
Consort Electronics	(0252) 871717
Hawke Electronics	01-979 7799
Merlin Electronics	(0622) 678888
Micromark Electronics	(0628) 72631
Polar Electronics	(0525) 377093
Solid State Scientific	01 748 3143
Thame Components	084 421 4561

**Semiconductor manufacturers
and their UK distributors**

 Manufacturer: **AMERICAN MICROS (AMI)**

Distributors	Telephone
Active Electronics	(0494) 441129
Avigupo of Britain	(0628) 34555
Consort Electronics	(0252) 871717
Merlin Electronics	(0622) 678888
Polar Electronics	(0525) 377093
Regisbrook	(0734) 665965
VSI Electronics	(0279) 35477

 Manufacturer **ANALOG DEVICES**

Distributors	Telephone
Active Electronics	(0494) 441129
Avigupo of Britain	(0628) 34555
Merlin Electronics	(0622) 678888
Polar Electronics	(0525) 377093

**Elektor Electronics
Datasheet-33**
**Transistors
Types BUX80 & BUX81**

Type	Characteristics	Limits																				
The BUX80 & BUX81 are n-p-n transistors for fast switching and motor control	Collector cut-off current, I_{CES} ($U_{CES} = \max; U_{BE} = 0 V$)	$\leq 1 mA$																				
	Collector-emitter saturation voltage, $U_{CE(sat)}$ ($I_B = 1 A; I_C = 5 A$) ($I_B = 2.5 A; I_C = 8 A$)	$\leq 1.5 V$ $\leq 3.0 V$																				
	Base-emitter saturation voltage, $U_{BE(sat)}$ ($I_B = 1 A; I_C = 5 A$) ($I_B = 2.5 A; I_C = 8 A$)	$\leq 1.4 V$ $\leq 1.8 V$																				
	DC current gain, h_{FE}	typ 30																				
	Current gain - bandwidth product, f_T	typ 6 MHz																				
		<table border="0"> <tr> <td>BUX80</td> <td>BUX81</td> </tr> <tr> <td>U_{CEO} 400 V</td> <td>450 V</td> </tr> <tr> <td>U_{CER} 500 V*</td> <td>500 V*</td> </tr> <tr> <td>U_{CES} 800 V**</td> <td>1000 V**</td> </tr> <tr> <td>I_C 10 A</td> <td>10 A</td> </tr> <tr> <td>I_{CM} 15 A</td> <td>15 A</td> </tr> <tr> <td>I_B 4 A</td> <td>4 A</td> </tr> <tr> <td>I_{BM} 6 A</td> <td>6 A</td> </tr> <tr> <td>P_c 100 W**</td> <td>100 W**</td> </tr> <tr> <td>T_j 150°C</td> <td>150°C</td> </tr> </table>	BUX80	BUX81	U_{CEO} 400 V	450 V	U_{CER} 500 V*	500 V*	U_{CES} 800 V**	1000 V**	I_C 10 A	10 A	I_{CM} 15 A	15 A	I_B 4 A	4 A	I_{BM} 6 A	6 A	P_c 100 W**	100 W**	T_j 150°C	150°C
BUX80	BUX81																					
U_{CEO} 400 V	450 V																					
U_{CER} 500 V*	500 V*																					
U_{CES} 800 V**	1000 V**																					
I_C 10 A	10 A																					
I_{CM} 15 A	15 A																					
I_B 4 A	4 A																					
I_{BM} 6 A	6 A																					
P_c 100 W**	100 W**																					
T_j 150°C	150°C																					
		with R_{th} 50R																				
		* peak value; B-E shorted																				
		** up to T_C 40°C																				
	Data are valid only for conditions stated.																					

Subscription Order

Name

Address

Pin Code

NEW

M. Wiegand
PROJECTS
AN ELEKTOR BOOK FROM HOLLAND

**PACKED
WITH PROJECTS**

Includes information on:

- Home work - Table.
- Hardware & Components
- Checklists
- Soldering
- Component data & codes.

PRICE Rs. **50/-**
 R.P.P. FREE

ATTENTION!
SPECIAL OFFER TO
ELEKTOR INDIA SUBSCRIBERS

- Send a 3 year Subscription for elektor India magazine and get this book **free**.
- Existing subscribers can order this book @ 30% discount. Please mention Subscription number (or send latest address label from magazine envelope)

Please send amount by
M.O./D.D./P.O./ only to:

ELEKTOR
ELECTRONICS
PVT Ltd.

52-C Proctor Road
 Grant Road (E) Bombay - 400 007.
 Phones: 3674591/369478
 Telex No. (011) 76661 ELEK IN

**This offer is valid to
 payments received from
 9.06.87 to 30.09.87**